

# Rohrkupplungen und Fittings

Tube couplings and fittings

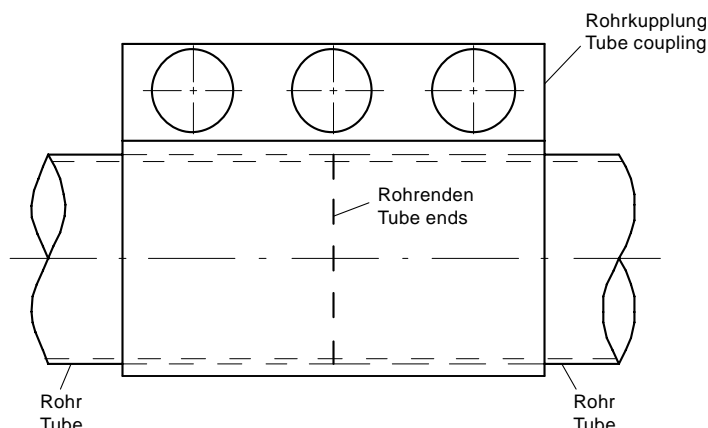

### Einsatzgebiete

Die Rohrkupplungen werden insbesondere bei Förder- und Produktionsanlagen eingesetzt, in denen Schüttgüter unterschiedlicher Art, wie Getreide, Mehl, Granulat, Pulver, Staub etc., mit Unter- oder Überdruck pneumatisch transportiert werden. Bevorzugte Anwendungsbereiche sind die Chemie-, Pharma-, Kunststoff- und Lebensmittelindustrie.

### Montage

Die Außendurchmesser der zu verbindenden Rohre müssen jeweils gleich und kreisrund sein und dem Innendurchmesser der Rohrkupplung entsprechen. Die Rohrkupplung wird über die gratfreien Rohrenden geschoben, so dass der Edelstahl-Erdungsstreifen für die Entladung statischer Elektrizität an den Außenflächen der Rohrenden anliegt. Die Rohrenden müssen in der Mitte der Rohrkupplung aneinander stoßen. Die Verzahnung der Dichtung soll sich gegenüber der Verschraubung befinden. Die Verzahnungen der Zwischenhülse und der Dichtung müssen gegeneinander versetzt sein. Die Schrauben sind gleichmäßig anzuziehen. Die Oberkanten der Klemmleisten dürfen sich berühren, die Klemmleisten dürfen aber nicht zusammengedrückt werden. Die schweren Rohrkupplungen können zur Sicherung gegen Druckstöße zusätzlich mit einer Sicherungsschelle versehen werden.

### Merkmale

- Größen: DN34 bis DN280 (DN = Rohraußendurchmesser)  
Zulässige Rohraußendurchmesser:  
Rohr Ø 34 - Ø 75 = -1 mm, +1 mm  
Rohr Ø 80 - Ø 280 = -1 mm, +2 mm
- Baulängen: 100 mm, 150 mm, 200 mm
- Gehäuse: Stahl verzinkt und rostfreier Edelstahl AISI304
- Dichtungen: NR/SBR schwarz -20 bis 70 °C; SBR weiß, lebensmittelgeeignet, -40 bis 90 °C; Silikon rot -60 bis 250 °C
- Druckdicht: Leichte Ausführung 1,5 bar, schwere Ausf. 2 bar
- Druckstoßfestigkeit: Schwere Ausführung 8 bar

### Application

The Tube couplings are used especially for conveying systems and production lines with which various bulk goods as grain, flour, granule, powder, dust etc. can be conveyed pneumatically with low pressure or overpressure. Preferential fields of application are the chemical-, pharmaceutical-, plastic-, and food industry.

### Assembly

The outer diameters of the tubes which are to be connected must be equal in each case and circular and correspond with the inside diameter of the tube coupling. The tube coupling is pushed over the edgeless tube ends so that the static conductive grounding strip made of stainless steel has contact with the outer sides of the tube ends. The tube ends must come together in the middle of the coupling. The gasket toothing must be diametrically positioned to the screw joint. The sleeve toothing and the gasket toothing must be separate and must not be pushed upon each other. The screws must be tightened equally. The upper parts of the clamping collars can come together but the clamping collars should not be compressed. The heavy duty tube couplings are also available with an additional safety tube clamp as safeguard against pressure shocks.

### Features

- Sizes: DN34 up to DN280 (DN = Tube outer diameter)  
Permissible tube outer diameter:  
Tube Ø 34 - Ø 75 = -1 mm, +1 mm  
Tube Ø 80 - Ø 280 = -1 mm, +2 mm
- Length: 100 mm, 150 mm, 200 mm
- Housing: Steel zinc plated and stainless steel AISI304
- Gaskets: NR/SBR black -20 bis 70 °C; SBR weiß (food quality) -40 up to 90 °C; VMQ red -60 up to 250 °C
- Pressure: Light design 1,5 bar, heavy design 2 bar
- Pressure shockproof: Heavy design 8 bar

### Artikel

Artikel	Seite
Rohrkupplungen leicht RKL 150.....	268
Rohrkupplungen schwer RKS 100.....	268
Rohrkupplungen schwer RKS 150.....	269
Rohrkupplungen schwer RKS 200 .....	273
Sicherungsschellen .....	274
Reduzierstücke .....	276
Rohrbogen mit Großradius .....	278
Abzweigstücke .....	280
T-Stücke.....	281

### Articles

Articles	Page
Tube coupling light RKL 150.....	268
Tube coupling heavy RKS 100 .....	268
Tube coupling heavy RKS 150.....	269
Tube coupling heavy RKS 200 .....	273
Safety tube clamps .....	274
Reducing pieces .....	276
Pipe bends with large radius.....	278
Branch pieces .....	280
T-pieces.....	281

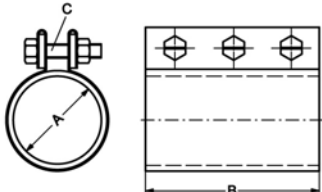
Rohrkupplungen und Fittings							Art.No.	EUR	Art.No.	EUR
<b>Rohrkupplung leicht RKL150</b> <b>Tube coupling light RKL150</b> 	DN	A	B	C			AISI304 NR-SBR schwarz		AISI304 SBR weiß	
	48	48	150	3 x M 8			570108	20,20	570208	20,90
	60	60	150	3 x M 8			570115	20,60	570215	21,20
	75	75	150	3 x M 8			570124	20,90	570224	21,90
	89	89	150	3 x M 8			570130	21,20	570230	22,40
	108	108	150	3 x M 8			570138	21,60	570238	22,90
	115	115	150	3 x M 8			570141	22,40	570241	23,60
	127	127	150	3 x M 8			570144	23,80	570244	25,30
	140	140	150	3 x M 8			570149	24,30	570249	26,10

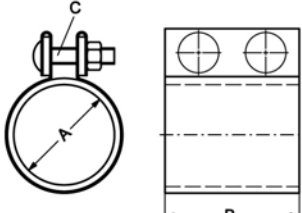
<b>Rohrkupplung schwer RKS 100, St.</b> <b>Tube coupling heavy RKS 100, st.</b> 	DN	A	B	C			Stahl verzinkt NR-SBR schwarz		Stahl verzinkt SBR weiß	
	34	34	100	2 x M 12			570301	18,70	570401	18,80
	38	38	100	2 x M 12			570302	19,10	570402	19,60
	39	39	100	2 x M 12			570303	19,20	570403	19,80
	45	45	100	2 x M 12			570307	19,40	570407	19,90
	50	50	100	2 x M 12			570309	19,50	570409	20,10
	55	55	100	2 x M 12			570312	19,60	570412	20,30
	60	60	100	2 x M 12			570315	19,70	570415	20,40
	63	63	100	2 x M 12			570316	19,80	570416	20,60
	65	65	100	2 x M 12			570317	20,10	570417	20,70
	70	70	100	2 x M 12			570320	20,20	570420	20,90
	75	75	100	2 x M 12			570323	20,40	570423	22,30
	80	80	100	2 x M 12			570325	20,90	570425	22,60

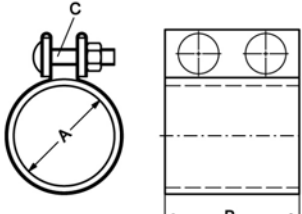
<b>Rohrkupplung schwer RKS 100</b> <b>Tube coupling heavy RKS 100</b> 	DN	A	B	C			AISI304 NR-SBR schwarz		AISI304 SBR weiß	
	34	34	100	2 x M 12			570501	33,90	570601	35,40
	38	38	100	2 x M 12			570502	35,30	570602	36,70
	39	39	100	2 x M 12			570503	35,60	570603	37,20
	45	45	100	2 x M 12			570507	36,60	570607	37,90
	50	50	100	2 x M 12			570509	36,90	570609	39,10
	55	55	100	2 x M 12			570512	37,80	570612	40,30
	60	60	100	2 x M 12			570515	38,60	570615	41,10
	63	63	100	2 x M 12			570516	39,10	570616	41,90
	65	65	100	2 x M 12			570517	40,10	570617	42,30
	70	70	100	2 x M 12			570520	40,80	570620	43,30
	75	75	100	2 x M 12			570523	41,70	570623	44,60
	80	80	100	2 x M 12			570525	42,60	570625	45,60

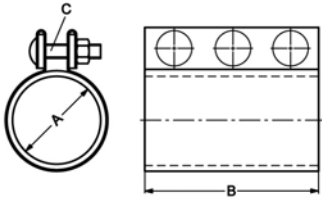
Rohrkupplungen und Fittings							Art.No.	EUR	Art.No.	EUR
Rohrkupplung schwer RKS 150, St. Tube coupling heavy RKS 150, st.	DN	A	B	C			Stahl verzinkt NR-SBR schwarz		Stahl verzinkt SBR weiß	
		38	38	150	3 x M 12			570702	22,60	570802
	39	39	150	3 x M 12			570703	23,00	570803	23,80
	45	45	150	3 x M 12			570707	23,30	570807	23,90
	50	50	150	3 x M 12			570709	23,60	570809	24,30
	55	55	150	3 x M 12			570712	23,80	570812	24,70
	60	60	150	3 x M 12			570715	24,20	570815	24,90
	63	63	150	3 x M 12			570716	25,60	570816	25,30
	65	65	150	3 x M 12			570717	24,80	570817	25,50
	70	70	150	3 x M 12			570720	25,10	570820	25,90
	75	75	150	3 x M 12			570723	25,40	570823	26,20
	80	80	150	3 x M 12			570725	25,60	570825	26,60
	83	83	150	3 x M 12			570726	25,90	570826	27,10
	85	85	150	3 x M 12			570728	26,25	570828	27,60
	89	89	150	3 x M 12			570730	26,60	570830	28,20
	95	95	150	3 x M 12			570732	27,20	570832	28,70
	100	100	150	3 x M 12			570733	27,70	570833	28,90
	102	102	150	3 x M 12			570734	28,00	570834	29,30
	105	105	150	3 x M 12			570736	28,60	570836	29,80
	108	108	150	3 x M 12			570738	29,20	570838	30,70
	110	110	150	3 x M 12			570739	29,90	570839	32,40
	115	115	150	3 x M 12			570741	31,10	570841	32,80
	120	120	150	3 x M 12			570742	31,40	570842	32,90
	125	125	150	3 x M 12			570743	31,70	570843	33,20
	127	127	150	3 x M 12			570744	31,90	570844	33,40
	129	129	150	3 x M 12			570745	32,40	570845	33,90
	133	133	150	3 x M 12			570747	32,60	570847	34,20
	135	135	150	3 x M 12			570748	32,90	570848	34,40
	140	140	150	3 x M 12			570749	33,20	570849	34,60
	146	146	150	3 x M 12			570753	33,70	570853	35,10
	150	150	150	3 x M 12			570754	34,20	570854	35,80
	152	152	150	3 x M 12			570755	34,60	570855	36,60
	155	155	150	3 x M 12			570757	34,90	570857	37,20
	159	159	150	3 x M 12			570758	35,80	570858	37,70
	168	168	150	3 x M 12			570760	36,40	570860	38,30
	174	174	150	3 x M 12			570763	36,90	570863	39,20
	180	180	150	3 x M 12			570766	37,60	570866	40,20
	191	191	150	3 x M 12			570769	38,10	570869	40,60
	193	193	150	3 x M 12			570770	38,60	570870	41,20
	200	200	150	3 x M 12			570773	39,10	570873	41,50
	203	203	150	3 x M 12			570774	39,80	570874	42,20
	210	210	150	3 x M 12			570777	40,30	570877	42,90
	219	219	150	3 x M 12			570778	41,20	570878	43,60
	230	230	150	3 x M 12			570781	42,10	570881	44,30
	250	250	150	3 x M 12			570784	42,70	570884	45,30
	260	260	150	3 x M 12			570786	44,00	570886	46,40
	266	266	150	3 x M 12			570787	44,70	570887	47,40
	273	273	150	3 x M 12			570789	45,60	570889	47,80
	280	280	150	3 x M 12			570790	46,10	570890	48,60

## Rohrkupplungen und Fittings

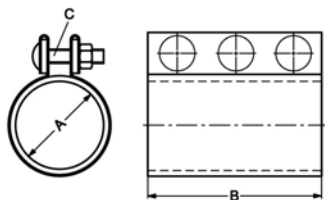
**Art.No.**
**EUR**
**Art.No.**
**EUR**
**Rohrkupplung schwer RKS 150, St.**  
**Tube coupling heavy RKS 150, st.**

**Stahl verzinkt**  
**Silikon rot**

DN	A	B	C						
38	38	150	3 x M 12					572902	31,20
39	39	150	3 x M 12					572903	31,20
45	45	150	3 x M 12					572907	33,20
50	50	150	3 x M 12					572909	33,20
55	55	150	3 x M 12					572912	33,80
60	60	150	3 x M 12					572915	33,80
63	63	150	3 x M 12					572916	35,10
65	65	150	3 x M 12					572917	35,10
70	70	150	3 x M 12					572920	35,10
75	75	150	3 x M 12					572923	36,20
80	80	150	3 x M 12					572925	36,20
83	83	150	3 x M 12					572926	38,40
85	85	150	3 x M 12					572928	38,40
89	89	150	3 x M 12					572930	38,40
95	95	150	3 x M 12					572932	39,10
100	100	150	3 x M 12					572933	39,10
102	102	150	3 x M 12					572934	39,10
105	105	150	3 x M 12					572936	39,70
108	108	150	3 x M 12					572938	39,70
110	110	150	3 x M 12					572939	39,70
115	115	150	3 x M 12					572941	41,80
120	120	150	3 x M 12					572942	41,80
125	125	150	3 x M 12					572943	41,80
127	127	150	3 x M 12					572944	41,80
129	129	150	3 x M 12					572945	43,70
133	133	150	3 x M 12					572947	43,70
135	135	150	3 x M 12					572948	43,70
140	140	150	3 x M 12					572949	43,70
146	146	150	3 x M 12					572953	47,30
150	150	150	3 x M 12					572954	47,30
152	152	150	3 x M 12					572955	47,30
155	155	150	3 x M 12					572957	47,30
159	159	150	3 x M 12					572958	49,80
168	168	150	3 x M 12					572960	49,80
174	174	150	3 x M 12					572963	49,80
180	180	150	3 x M 12					572966	53,60
191	191	150	3 x M 12					572969	53,60
193	193	150	3 x M 12					572970	53,60
200	200	150	3 x M 12					572973	53,60
203	203	150	3 x M 12					572974	53,60
210	210	150	3 x M 12					572977	59,20
219	219	150	3 x M 12					572978	59,20
230	230	150	3 x M 12					572981	59,20
250	250	150	3 x M 12					572984	59,20
260	260	150	3 x M 12					572986	62,50
266	266	150	3 x M 12					572987	62,50
273	273	150	3 x M 12					572989	62,50
280	280	150	3 x M 12					572990	62,50

## Rohrkupplungen und Fittings

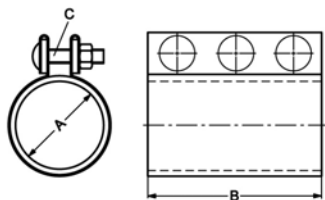
**Rohrkupplung schwer RKS 150**  
**Tube coupling heavy RKS 150**



DN	A	B	C			Art.No.		EUR	
						AISI304 NR-SBR schwarz	AISI304 SBR weiß		
38	38	150	3 x M 12			570902	41,20	571002	42,20
39	39	150	3 x M 12			570903	41,50	571003	42,50
45	45	150	3 x M 12			570907	41,80	571007	42,90
50	50	150	3 x M 12			570909	43,20	571009	43,70
55	55	150	3 x M 12			570912	43,70	571012	44,60
60	60	150	3 x M 12			570915	44,30	571015	45,40
63	63	150	3 x M 12			570916	45,10	571016	45,90
65	65	150	3 x M 12			570917	42,30	571017	46,10
70	70	150	3 x M 12			570920	45,70	571020	46,50
75	75	150	3 x M 12			570923	45,90	571023	47,10
80	80	150	3 x M 12			570925	46,40	571025	47,90
83	83	150	3 x M 12			570926	46,70	571026	48,20
85	85	150	3 x M 12			570928	47,20	571028	48,40
89	89	150	3 x M 12			570930	47,90	571030	48,70
95	95	150	3 x M 12			570932	48,10	571032	49,30
100	100	150	3 x M 12			570933	48,40	571033	49,60
102	102	150	3 x M 12			570934	48,40	571034	49,90
105	105	150	3 x M 12			570936	49,20	571036	50,50
108	108	150	3 x M 12			570938	49,60	571038	50,90
110	110	150	3 x M 12			570939	49,80	571039	51,00
115	115	150	3 x M 12			570941	50,50	571041	51,30
120	120	150	3 x M 12			570942	50,80	571042	51,90
125	125	150	3 x M 12			570943	51,10	571043	52,10
127	127	150	3 x M 12			570944	51,30	571044	52,40
129	129	150	3 x M 12			570945	51,90	571045	53,10
133	133	150	3 x M 12			570947	52,40	571047	53,80
135	135	150	3 x M 12			570948	53,40	571048	55,10
140	140	150	3 x M 12			570949	54,20	571049	56,30
146	146	150	3 x M 12			570953	55,90	571053	57,70
150	150	150	3 x M 12			570954	56,20	571054	57,90
152	152	150	3 x M 12			570955	56,40	571055	58,20
155	155	150	3 x M 12			570957	56,80	571057	58,60
159	159	150	3 x M 12			570958	57,20	571058	59,10
168	168	150	3 x M 12			570960	57,60	571060	59,80
174	174	150	3 x M 12			570963	58,70	571063	60,20
180	180	150	3 x M 12			570966	59,90	571066	61,60
191	191	150	3 x M 12			570969	60,80	571069	62,10
193	193	150	3 x M 12			570970	61,20	571070	62,60
200	200	150	3 x M 12			570973	61,60	571073	63,10
203	203	150	3 x M 12			570974	62,10	571074	63,90
210	210	150	3 x M 12			570977	62,90	571077	64,90
219	219	150	3 x M 12			570978	63,40	571078	65,80
230	230	150	3 x M 12			570981	64,50	571081	66,80
250	250	150	3 x M 12			570984	66,60	571084	67,70
260	260	150	3 x M 12			570986	67,10	571086	69,40
266	266	150	3 x M 12			570987	67,40	571087	70,20
273	273	150	3 x M 12			570989	68,30	571089	70,60
280	280	150	3 x M 12			570990	69,60	571090	71,80

## Rohrkupplungen und Fittings

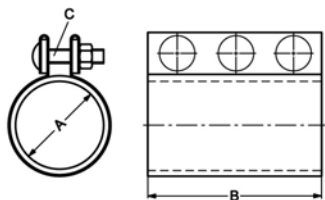
**Art.No.**
**EUR**
**Art.No.**
**EUR**
**Rohrkupplung schwer RKS 150**  
**Tube coupling heavy RKS 150**

DN	A	B	C					AISI304 Silikon rot	
38	38	150	3 x M 12					573002	44,20
39	39	150	3 x M 12					573003	44,20
45	45	150	3 x M 12					573007	46,20
50	50	150	3 x M 12					573009	46,20
55	55	150	3 x M 12					573012	46,70
60	60	150	3 x M 12					573015	46,70
63	63	150	3 x M 12					573016	47,90
65	65	150	3 x M 12					573017	47,90
70	70	150	3 x M 12					573020	47,90
75	75	150	3 x M 12					573023	51,10
80	80	150	3 x M 12					573025	51,10
83	83	150	3 x M 12					573026	51,90
85	85	150	3 x M 12					573028	51,90
89	89	150	3 x M 12					573030	51,90
95	95	150	3 x M 12					573032	54,80
100	100	150	3 x M 12					573033	54,80
102	102	150	3 x M 12					573034	54,80
105	105	150	3 x M 12					573036	56,30
108	108	150	3 x M 12					573038	56,30
110	110	150	3 x M 12					573039	56,30
115	115	150	3 x M 12					573041	58,90
120	120	150	3 x M 12					573042	58,90
125	125	150	3 x M 12					573043	58,90
127	127	150	3 x M 12					573044	58,90
129	129	150	3 x M 12					573045	61,10
133	133	150	3 x M 12					573047	61,10
135	135	150	3 x M 12					573048	61,10
140	140	150	3 x M 12					573049	61,10
146	146	150	3 x M 12					573053	65,80
150	150	150	3 x M 12					573054	65,80
152	152	150	3 x M 12					573055	65,80
155	155	150	3 x M 12					573057	65,80
159	159	150	3 x M 12					573058	68,70
168	168	150	3 x M 12					573060	68,70
174	174	150	3 x M 12					573063	68,70
180	180	150	3 x M 12					573066	73,50
191	191	150	3 x M 12					573069	73,50
193	193	150	3 x M 12					573070	73,50
200	200	150	3 x M 12					573073	73,50
203	203	150	3 x M 12					573074	73,50
210	210	150	3 x M 12					573077	80,60
219	219	150	3 x M 12					573078	80,60
230	230	150	3 x M 12					573081	80,60
250	250	150	3 x M 12					573084	80,60
260	260	150	3 x M 12					573086	85,50
266	266	150	3 x M 12					573087	85,50
273	273	150	3 x M 12					573089	85,50
280	280	150	3 x M 12					573090	85,50

**LINNE MANN**

 Rohrverbindungen • Edelstahlarmaturen  
 Pipe connections • Stainless steel fittings

 LINNEMANN GmbH • Heerweg 14-16  
 72070 Tübingen / Germany

 Fon: +49 (0) 7071 97555-0  
 Fax: +49 (0) 7071 97555-10

 E-Mail: info@linnemann-online.com  
 Internet: www.linnemann-online.com

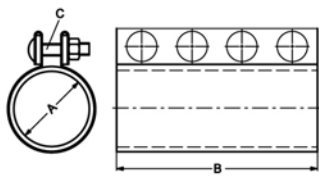
Rohrkupplungen und Fittings							Art.No.	EUR	Art.No.	EUR
<b>Rohrkupplung schwer RKS 200, St.</b> <b>Tube coupling heavy RKS 200, st.</b> 	DN	A	B	C			Stahl verzinkt NR-SBR schwarz		Stahl verzinkt SBR weiß	
	83	83	200	4 x M 12			571126	31,60	571226	32,80
	85	85	200	4 x M 12			571128	32,50	571228	34,40
	89	89	200	4 x M 12			571130	34,50	571230	35,80
	95	95	200	4 x M 12			571132	34,80	571232	36,30
	100	100	200	4 x M 12			571133	35,60	571233	36,70
	102	102	200	4 x M 12			571134	36,20	571234	37,10
	105	105	200	4 x M 12			571136	36,90	571236	37,90
	108	108	200	4 x M 12			571138	37,60	571238	38,80
	110	110	200	4 x M 12			571139	38,30	571239	40,10
	115	115	200	4 x M 12			571141	39,80	571241	41,20
	120	120	200	4 x M 12			571142	40,20	571242	41,90
	125	125	200	4 x M 12			571143	41,20	571243	42,50
	127	127	200	4 x M 12			571144	41,50	571244	43,30
	129	129	200	4 x M 12			571145	42,80	571245	44,20
	133	133	200	4 x M 12			571147	43,90	571247	45,10
	135	135	200	4 x M 12			571148	44,90	571248	45,90
	140	140	200	4 x M 12			571149	45,70	571249	46,80
	146	146	200	4 x M 12			571153	46,80	571253	48,20
	150	150	200	4 x M 12			571154	48,40	571254	49,20
	152	152	200	4 x M 12			571155	49,60	571255	50,30
	155	155	200	4 x M 12			571157	50,90	571257	51,70
	159	159	200	4 x M 12			571158	51,90	571258	53,80
	168	168	200	4 x M 12			571160	53,80	571260	56,30
	174	174	200	4 x M 12			571163	55,30	571263	57,10
	180	180	200	4 x M 12			571166	57,60	571266	58,70
	191	191	200	4 x M 12			571169	58,40	571269	59,90
	193	193	200	4 x M 12			571170	59,70	571270	61,10
	200	200	200	4 x M 12			571173	60,60	571273	62,60
	203	203	200	4 x M 12			571174	61,60	571274	63,90
210	210	200	4 x M 12			571177	63,90	571277	65,60	
219	219	200	4 x M 12			571178	64,70	571278	67,20	
230	230	200	4 x M 12			571181	66,50	571281	68,60	
250	250	200	4 x M 12			571184	67,60	571284	70,80	
260	260	200	4 x M 12			571186	69,50	571286	72,90	
266	266	200	4 x M 12			571187	70,20	571287	73,70	
273	273	200	4 x M 12			571189	70,70	571289	74,40	
280	280	200	4 x M 12			571190	71,30	571290	75,10	

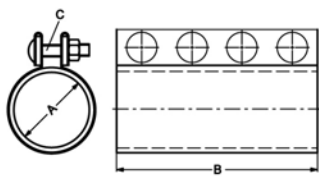
<b>Rohrkupplung schwer RKS 200</b> <b>Tube coupling heavy RKS 200</b> 	DN	A	B	C			AISI304 NR-SBR schwarz		AISI304 SBR weiß	
	83	83	200	4 x M 12			571326	55,90	571426	58,70
	85	85	200	4 x M 12			571328	56,80	571428	59,30
	89	89	200	4 x M 12			571330	57,70	571430	60,50
	95	95	200	4 x M 12			571332	58,60	571432	61,20
	100	100	200	4 x M 12			571333	59,30	571433	62,10
	102	102	200	4 x M 12			571334	60,10	571434	63,20
	105	105	200	4 x M 12			571336	61,20	571436	63,70
	108	108	200	4 x M 12			571338	61,60	571438	64,20
	110	110	200	4 x M 12			571339	61,90	571439	64,50

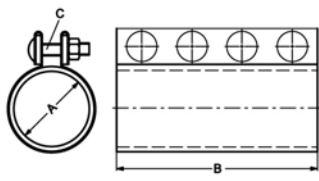
Rohrkupplungen und Fittings							Art.No.	EUR	Art.No.	EUR
<b>Rohrkupplung schwer RKS 200</b> <b>Tube coupling heavy RKS 200</b> 	DN	A	B	C			AISI304 NR-SBR schwarz		AISI304 SBR weiß	
	115	115	200	4 x M 12			571341	<b>62,50</b>	571441	<b>65,30</b>
	120	120	200	4 x M 12			571342	<b>63,20</b>	571442	<b>66,10</b>
	125	125	200	4 x M 12			571343	<b>63,60</b>	571443	<b>66,90</b>
	127	127	200	4 x M 12			571344	<b>64,40</b>	571444	<b>68,20</b>
	129	129	200	4 x M 12			571345	<b>65,00</b>	571445	<b>68,80</b>
	133	133	200	4 x M 12			571347	<b>65,90</b>	571447	<b>69,50</b>
	135	135	200	4 x M 12			571348	<b>66,80</b>	571448	<b>70,30</b>
	140	140	200	4 x M 12			571349	<b>67,70</b>	571449	<b>70,70</b>
	146	146	200	4 x M 12			571353	<b>68,90</b>	571453	<b>71,80</b>
	150	150	200	4 x M 12			571354	<b>69,50</b>	571454	<b>73,20</b>
	152	152	200	4 x M 12			571355	<b>70,40</b>	571455	<b>74,60</b>
	155	155	200	4 x M 12			571357	<b>71,50</b>	571457	<b>75,90</b>
	159	159	200	4 x M 12			571358	<b>72,90</b>	571458	<b>77,90</b>
	168	168	200	4 x M 12			571360	<b>73,80</b>	571460	<b>79,60</b>
	174	174	200	4 x M 12			571363	<b>75,70</b>	571463	<b>80,40</b>
	180	180	200	4 x M 12			571366	<b>77,90</b>	571466	<b>83,20</b>
	191	191	200	4 x M 12			571369	<b>79,20</b>	571469	<b>83,90</b>
	193	193	200	4 x M 12			571370	<b>80,40</b>	571470	<b>84,80</b>
	200	200	200	4 x M 12			571373	<b>81,80</b>	571473	<b>85,70</b>
	203	203	200	4 x M 12			571374	<b>82,40</b>	571474	<b>86,10</b>
	210	210	200	4 x M 12			571377	<b>84,60</b>	571477	<b>88,70</b>
	219	219	200	4 x M 12			571378	<b>86,00</b>	571478	<b>90,20</b>
	230	230	200	4 x M 12			571381	<b>88,40</b>	571481	<b>91,60</b>
	250	250	200	4 x M 12			571384	<b>89,60</b>	571484	<b>93,80</b>
	260	260	200	4 x M 12			571386	<b>90,90</b>	571486	<b>97,60</b>
	266	266	200	4 x M 12			571387	<b>91,90</b>	571487	<b>98,30</b>
273	273	200	4 x M 12			571389	<b>92,80</b>	571489	<b>99,60</b>	
280	280	200	4 x M 12			571390	<b>93,90</b>	571490	<b>100,30</b>	

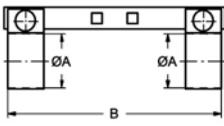
<b>Sicherungsschelle für RKS 100</b> <b>Safety tube clamp for RKS 100</b> 	DN	A	B				Stahl verzinkt/ Alu		AISI304/Alu	
	38	38	300				571502	<b>12,50</b>	571602	<b>22,30</b>
	39	39	300				571503	<b>12,50</b>	571603	<b>22,30</b>
	45	45	300				571507	<b>12,50</b>	571607	<b>22,30</b>
	50	50	300				571509	<b>12,50</b>	571609	<b>22,30</b>
	55	55	300				571512	<b>12,50</b>	571612	<b>22,30</b>
	60	60	300				571515	<b>12,50</b>	571615	<b>22,30</b>
	63	63	300				571516	<b>12,50</b>	571616	<b>22,30</b>
	65	65	300				571517	<b>12,50</b>	571617	<b>22,30</b>
	70	70	300				571520	<b>12,50</b>	571620	<b>22,30</b>
	75	75	300				571523	<b>13,80</b>	571623	<b>24,40</b>
	80	80	300				571525	<b>13,80</b>	571625	<b>24,40</b>

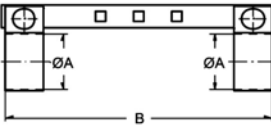

Rohrkupplungen und Fittings							Art.No.	EUR	Art.No.	EUR
<b>Sicherungsschelle für RKS 150</b> <b>Safety tube clamp for RKS 150</b>  	DN	A	B				Stahl verzinkt/ Alu		AISI304/Alu	
	38	38	350				571702	12,50	571802	22,30
	39	39	350				571703	12,50	571803	22,30
	45	45	350				571707	12,50	571807	22,30
	50	50	350				571709	12,50	571809	22,30
	55	55	350				571712	12,50	571812	22,30
	60	60	350				571715	12,50	571815	22,30
	63	63	350				571716	12,50	571816	22,30
	65	65	350				571717	12,50	571817	22,30
	70	70	350				571720	12,50	571820	22,30
	75	75	350				571723	13,80	571823	24,40
	80	80	350				571725	13,80	571825	24,40
	83	83	350				571726	13,80	571826	24,40
	85	85	350				571728	13,80	571828	24,40
	89	89	350				571730	13,80	571830	24,40
	95	95	350				571732	16,10	571832	27,60
	100	100	350				571733	16,10	571833	27,60
	102	102	350				571734	16,10	571834	27,60
	105	105	350				571736	16,10	571836	27,60
	108	108	350				571738	16,10	571838	27,60
	110	110	350				571739	16,10	571839	27,60
	115	115	350				571741	17,80	571841	28,50
	120	120	350				571742	17,80	571842	28,50
	125	125	350				571743	17,80	571843	28,50
	127	127	350				571744	17,80	571844	28,50
	129	129	350				571745	17,80	571845	30,40
	133	133	350				571747	17,80	571847	30,40
	135	135	350				571748	17,80	571848	30,40
	140	140	350				571749	17,80	571849	30,40
	146	146	350				571753	19,10	571853	32,80
150	150	350				571754	19,10	571854	32,80	
152	152	350				571755	19,10	571855	32,80	
155	155	350				571757	19,10	571857	32,80	
159	159	350				571758	19,10	571858	32,80	
168	168	350				571760	19,10	571860	32,80	
174	174	350				571763	19,10	571863	32,80	
180	180	350				571766	21,60	571866	37,60	
191	191	350				571769	21,60	571869	37,60	
193	193	350				571770	21,60	571870	37,60	
200	200	350				571773	21,60	571873	37,60	
203	203	350				571774	21,60	571874	37,60	
210	210	350				571777	23,00	571877	39,70	
219	219	350				571778	23,00	571878	39,70	
230	230	350				571781	23,00	571881	39,70	
250	250	350				571784	23,00	571884	39,70	
260	260	350				571786	23,00	571886	39,70	
266	266	350				571787	23,00	571887	39,70	
273	273	350				571789	23,00	571889	39,70	
280	280	350				571790	23,00	571890	39,70	

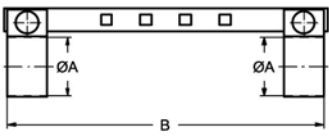
Rohrkupplungen und Fittings							Art.No.	EUR	Art.No.	EUR
<b>Sicherungsschelle für RKS 200</b> <b>Safety tube clamp for RKS 200</b>  	DN	A	B				Stahl verzinkt/ Alu		AISI304/Alu	
	83	83	400				571926	16,30	572626	25,20
	85	85	400				571928	16,30	572628	25,20
	89	89	400				571930	16,30	572630	25,20
	95	95	400				571932	19,10	572632	28,70
	100	100	400				571933	19,10	572633	28,70
	102	102	400				571934	19,10	572634	28,70
	105	105	400				571936	19,10	572636	28,70
	108	108	400				571938	19,10	572638	28,70
	110	110	400				571939	19,10	572639	28,70
	115	115	400				571941	20,30	572641	30,20
	120	120	400				571942	20,30	572642	30,20
	125	125	400				571943	20,30	572643	30,20
	127	127	400				571944	20,30	572644	30,20
	129	129	400				571945	20,30	572645	32,40
	133	133	400				571947	20,30	572647	32,40
	135	135	400				571948	20,30	572648	32,40
	140	140	400				571949	20,30	572649	32,40
	146	146	400				571953	24,20	572653	35,20
	150	150	400				571954	24,20	572654	35,20
	152	152	400				571955	24,20	572655	35,20
	155	155	400				571957	24,20	572657	35,20
	159	159	400				571958	24,20	572658	35,20
	168	168	400				571960	24,20	572660	35,20
	174	174	400				571963	24,20	572663	35,20
	180	180	400				571966	25,60	572666	39,90
	191	191	400				571969	25,60	572669	39,90
	193	193	400				571970	25,60	572670	39,90
	200	200	400				571973	25,60	572673	39,90
	203	203	400				571974	25,60	572674	39,90
210	210	400				571977	26,80	572677	41,90	
219	219	400				571978	26,80	572678	41,90	
230	230	400				571981	26,80	572681	41,90	
250	250	400				571984	26,80	572684	41,90	
260	260	400				571986	26,80	572686	41,90	
266	266	400				571987	26,80	572687	41,90	
273	273	400				571989	26,80	572689	41,90	
280	280	400				571990	26,80	572690	41,90	

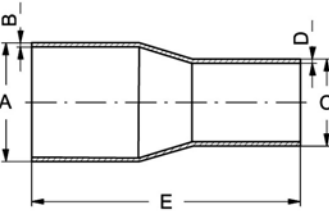
<b>Reduzierstück</b> <b>Reducing piece</b>  	DN	A	B	C	D	E			AISI304	
	40-38	40	1,5	38	1,5	150			573201	30,80
	50-38	50	1,5	38	1,5	150			573202	35,60
	50-40	50	1,5	40	1,5	150			573203	33,20
	50-45	50	1,5	45	1,5	150			573204	34,10
	54-38	54	2	38	1,5	200			573205	66,60
	54-40	54	2	40	1,5	200			573206	38,70
	54-45	54	2	45	1,5	200			573207	37,20
	54-50	54	2	50	1,5	200			573208	36,90
	60,3-38	60,3	2	38	1,5	200			573209	65,20

Rohrkupplungen und Fittings							Art.No.	EUR	Art.No.	EUR
<b>Reduzierstück</b> <b>Reducing piece</b>	DN	A	B	C	D	E			AISI304	
		60,3-40	60,3	2	40	1,5	200			573210
	60,3-45	60,3	2	45	1,5	200			573211	41,70
	60,3-50	60,3	2	50	1,5	200			573212	42,00
	60,3-54	60,3	2	54	2	200			573213	42,60
	65-45	65	2	45	1,5	200			573216	44,50
	65-50	65	2	50	1,5	200			573217	45,70
	65-60,3	65	2	60,3	2	200			573218	50,20
	70-40	70	2	40	1,5	300			573220	92,40
	70-45	70	2	45	1,5	200			573221	94,70
	70-50	70	2	50	1,5	200			573222	97,10
	70-54	70	2	54	2	200			573223	96,70
	70-60,3	70	2	60,3	2	200			573224	74,00
	70-65	70	2	65	2	200			573225	73,20
	76,1-38	76,1	2	38	1,5	250			573226	99,80
	76,1-40	76,1	2	40	1,5	250			573227	100,10
	76,1-45	76,1	2	45	1,5	250			573228	84,80
	76,1-48,3	76,1	2	48,3	2	250			573229	84,30
	76,1-50	76,1	2	50	1,5	200			573230	93,80
	76,1-54	76,1	2	54	2	250			573231	95,10
	76,1-60,3	76,1	2	60,3	2	200			573232	75,20
	76,1-65	76,1	2	65	2	200			573233	74,30
	76,1-70	76,1	2	70	2	200			573234	60,90
	80-50	80	2	50	1,5	300			573235	98,10
	80-54	80	2	54	2	300			573236	100,30
	80-60,3	80	2	60,3	2	200			573237	77,70
	80-65	80	2	65	2	200			573238	81,10
	80-70	80	2	70	2	200			573239	79,30
	80-76,1	80	2	76,1	2	200			573240	80,70
	84-70	84	2	70	2	250			573245	86,90
	84-76,1	84	2	76,1	2	250			573246	84,70
	84-80	84	2	80	2	250			573247	87,90
	88,9-60,3	88,9	2	60,3	2	300			573250	119,90
	88,9-65	88,9	2	65	2	300			573251	117,40
	88,9-70	88,9	2	70	2	300			573252	112,80
	88,9-76,1	88,9	2	76,1	2	300			573253	91,90
	88,9-80	88,9	2	80	2	300			573254	91,90
	88,9-84	88,9	2	84	2	300			573255	92,40
	101,6-60,3	101,6	2	60,3	2	300			573256	131,30
	101,6-70	101,6	2	70	2	300			573257	143,20
	101,6-76,1	101,6	2	76,1	2	300			573258	133,90
	101,6-80	101,6	2	80	2	300			573259	132,10
	101,6-84	101,6	2	84	2	300			573260	131,50
	101,6-88,9	101,6	2	88,9	2	300			573261	131,20
	104-80	104	2	80	2	300			573265	93,90
	104-84	104	2	84	2	300			573266	95,30
	104-88,9	104	2	88,9	2	300			573267	95,30
	104-100	104	2	100	1,5	300			573268	99,10
	104-101,6	104	2	101,6	2	300			573269	98,30

## Rohrkupplungen und Fittings

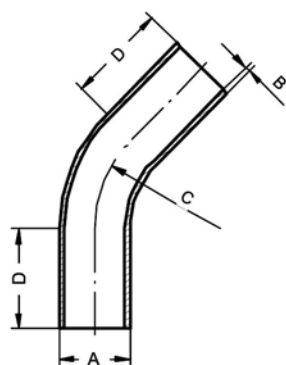
**Art.No.**
**EUR**
**Art.No.**
**EUR**
**Rohrbogen 45°, Großradius**  
**Pipe bend 45°, large radius**

DN	A	B	C	D				AISI304	
38-R70	38	1,5	70	100				572701	<b>32,10</b>
38-R250	38	1,5	250	100				572702	<b>41,40</b>
38-R500	38	1,5	500	100				572703	<b>42,80</b>
40-R75	40	1,5	75	100				572704	<b>35,70</b>
40-R250	40	1,5	250	100				572705	<b>47,10</b>
40-R500	40	1,5	500	200				572706	<b>47,10</b>
44,5-R60	44,5	1,5	60	90				572735	<b>34,30</b>
45-R75	45	1,5	75	100				572736	<b>36,90</b>
45-R300	45	1,5	300	200				572707	<b>41,40</b>
45-R500	45	1,5	500	200				572737	<b>46,10</b>
50-R75	50	1,5	75	100				572708	<b>35,50</b>
50-R250	50	1,5	250	100				572709	<b>41,40</b>
50-R500	50	1,5	500	200				572710	<b>47,10</b>
50-R800	50	1,5	800	200				572711	<b>96,50</b>
50-R1000	50	1,5	1000	200				572738	<b>96,50</b>
54-R150	54	2	150	100				572739	<b>68,80</b>
54-R250	54	2	250	100				572740	<b>60,40</b>
54-R500	54	2	500	200				572712	<b>73,70</b>
60,3-R115	60,3	2	115	150				572713	<b>58,20</b>
60,3-R250	60,3	2	250	200				572714	<b>78,30</b>
60,3-R500	60,3	2	500	200				572715	<b>76,60</b>
60,3-R800	60,3	2	800	200				572716	<b>117,90</b>
60,3-R1000	60,3	2	1000	200				572741	<b>125,10</b>
65-R115	65	2	115	150				572717	<b>70,90</b>
65-R250	65	2	250	200				572718	<b>88,50</b>
65-R500	65	2	500	200				572719	<b>100,40</b>
65-R800	65	2	800	200				572720	<b>147,50</b>
70-R500	70	2	500	200				572721	<b>115,10</b>
70-R800	70	2	800	200				572722	<b>150,30</b>
70-R1000	70	2	1000	100				572742	<b>150,30</b>
76,1-R500	76,1	2	500	200				572743	<b>122,40</b>
76,1-R800	76,1	2	800	200				572723	<b>165,10</b>
76,1-R1000	76,1	2	1000	200				572744	<b>158,30</b>
80-R150	80	2	150	200				572724	<b>108,10</b>
80-R500	80	2	500	200				572725	<b>115,20</b>
80-R800	80	2	800	200				572726	<b>172,50</b>
80-R1000	80	2	1000	200				572727	<b>186,80</b>
84-R500	84	2	500	200				572728	<b>126,30</b>
84-R800	84	2	800	200				572729	<b>172,40</b>
88,9-R500	88,9	2	500	200				572730	<b>129,60</b>
88,9-R800	88,9	2	800	200				572731	<b>172,40</b>
101,6-R500	101,6	2	500	200				572745	<b>147,40</b>
101,6-R800	101,6	2	800	200				572746	<b>170,10</b>
101,6-R1000	101,6	2	1000	200				572732	<b>195,70</b>
104-R500	104	2	500	200				572747	<b>180,60</b>
104-R800	104	2	800	200				572748	<b>175,70</b>
104-R1000	104	2	1000	200				572733	<b>206,90</b>
114,3-R800	114,3	2	800	200				572749	<b>204,50</b>
114,3-R1000	114,3	2	1000	200				572750	<b>204,50</b>

**LINNE MANN**  
Rohrverbindungen • Edelstahlarmaturen  
 Pipe connections • Stainless steel fittings

 LINNEMANN GmbH • Heerweg 14-16  
 72070 Tübingen / Germany

 Fon: +49 (0) 7071 97555-0  
 Fax: +49 (0) 7071 97555-10

 E-Mail: info@linnemann-online.com  
 Internet: www.linnemann-online.com

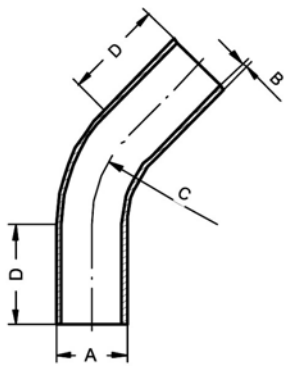
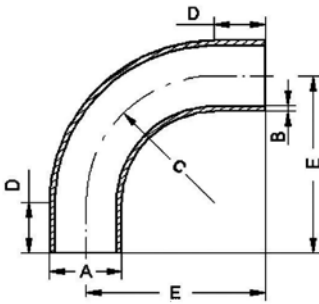
Rohrkupplungen und Fittings							Art.No.	EUR	Art.No.	EUR
<b>Rohrbogen 45°, Großradius</b> <b>Pipe bend 45°, large radius</b> 	DN	A	B	C	D		AISI304			
	129-R1000	129	2	1000	200			572734	425,30	
<b>Rohrbogen 90°, Großradius</b> <b>Pipe bend 90°, large radius</b> 	DN	A	B	C	D	E		AISI304		
	38-R75	38	1,5	70	100	175		572801	44,20	
	38-R250	38	1,5	250	100	350		572802	47,10	
	38-R500	38	1,5	500	100	600		572803	50,20	
	40-R75	40	1,5	75	100	175		572804	44,30	
	40-R250	40	1,5	250	100	350		572805	52,50	
	40-R500	40	1,5	500	200	700		572806	53,10	
	44,5-R60	44,5	1,5	60	90	160		572835	37,20	
	45-R75	45	1,5	75	100	175		572836	41,20	
	45-R300	45	1,5	300	200	500		572807	50,20	
	45-R500	45	1,5	500	200	700		572837	55,60	
	50-R75	50	1,5	75	100	175		572808	44,20	
	50-R250	50	1,5	250	100	350		572809	44,20	
	50-R500	50	1,5	500	200	700		572810	56,20	
	50-R800	50	1,5	800	200	1000		572811	135,80	
	50-R1000	50	1,5	1000	200	1200		572838	135,80	
	54-R150	54	2	150	100	250		572839	90,70	
	54-R250	54	2	250	100	350		572840	74,30	
	54-R500	54	2	500	200	700		572812	82,60	
	60,3-R115	60,3	2	115	150	265		572813	76,60	
	60,3-R250	60,3	2	250	200	450		572814	88,50	
	60,3-R500	60,3	2	500	200	700		572815	88,50	
	60,3-R800	60,3	2	800	200	1000		572816	132,80	
	60,3-R1000	60,3	2	1000	200	1200		572841	159,60	
	65-R115	65	2	115	150	265		572817	82,60	
	65-R250	65	2	250	200	450		572818	99,30	
	65-R500	65	2	500	200	700		572819	112,10	
	65-R800	65	2	800	200	1000		572820	164,60	
	70-R500	70	2	500	200	700		572821	123,90	
	70-R800	70	2	800	200	1000		572822	174,10	
	70-R1000	70	2	1000	200	1200		572842	174,10	
	76,1-R500	76,1	2	500	200	700		572843	138,10	
76,1-R800	76,1	2	800	200	1000		572823	194,50		
76,1-R1000	76,1	2	1000	200	1200		572844	206,90		
80-R150	80	2	150	200	350		572824	120,80		
80-R500	80	2	500	200	700		572825	143,80		
80-R800	80	2	800	200	1000		572826	201,30		

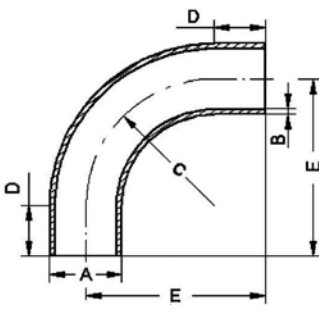
Rohrkupplungen und Fittings							Art.No.	EUR	Art.No.	EUR
<b>Rohrbogen 90°, Großradius</b> <b>Pipe bend 90°, large radius</b> 	DN	A	B	C	D	E			AISI304	
	80-R1000	80	2	1000	200	1200			572827	199,90
	84-R500	84	2	500	200	700			572828	143,80
	84-R800	84	2	800	200	1000			572829	201,30
	88,9-R500	88,9	2	500	200	700			572830	143,80
	88,9-R800	88,9	2	800	200	1000			572831	212,70
	101,6-R500	101,6	2	500	200	700			572845	210,80
	101,6-R800	101,6	2	800	200	1000			572846	244,40
	101,6-R1000	101,6	2	1000	200	1200			572832	241,50
	104-R500	104	2	500	200	700			572847	217,20
	104-R800	104	2	800	200	1000			572848	247,80
	104-R1000	104	2	1000	200	1200			572833	252,90
	114,3-R800	114,3	2	800	200	1000			572849	292,90
	114,3-R1000	114,3	2	1000	200	1200			572850	292,90
	129-R1000	129	2	1000	200	1200			572834	539,80
	154-R1000	154	2	1000	200	1150			572851	784,80

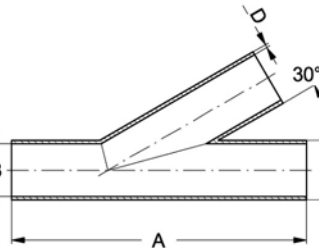
<b>Abzweigstück 30°</b> <b>Branch piece 30°</b> 	DN	A	B	C	D			AISI304	
	38x1,5	300	35	38	1,5			573302	53,10
	40x1,5	300	37	40	1,5			573304	53,10
	45x1,5	300	42	45	1,5			573307	53,80
	50x1,5	300	47	50	1,5			573309	54,90
	54x2	300	50	54	2			573311	65,50
	60,3x2	350	56,3	60,3	2			573315	76,60
	65x2	400	61	65	2			573317	97,90
	70x2	450	66	70	2			573320	102,90
	76,1x2	410	72,1	76,1	2			573324	108,80
	80x2	500	76	80	2			573325	128,50
	84x2	370	80	84	2			573327	123,40
	88,9x2	480	84,9	88,9	2			573330	134,90
	101,6x2	550	97,6	101,6	2			573334	168,90
	104x2	550	100	104	2			573335	190,70
	129x2	700	125	129	2			573345	207,20

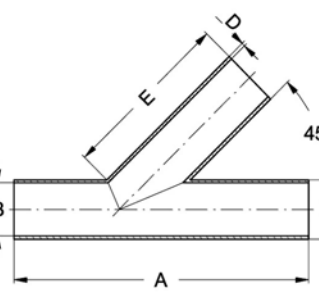
<b>Abzweigstück 45°</b> <b>Branch piece 45°</b> 	DN	A	B	C	D	E			AISI304	
	38x1,5	300	35	38	1,5	214			573402	49,70
	40x1,5	300	37	40	1,5	215			573404	49,70
	45x1,5	300	42	45	1,5	214			573407	51,40
	50x1,5	300	47	50	1,5	215			573409	51,90
	54x2	-	50	54	2	-			573411	57,80
	60,3x2	350	56,3	60,3	2	222			573415	74,20
	65x2	350	61	65	2	233			573417	85,10
	70x2	400	66	70	2	299			573420	93,90
	76,1x2	410	72,1	76,1	2	276			573424	102,10
	80x2	400	76	80	2	257			573425	108,90
	84x2	370	80	84	2	257			573427	115,90
	88,9x2	420	84,5	88,9	2	300			573430	121,40
	100x1,5	450	97	100	1,5	321			573433	Anfrage

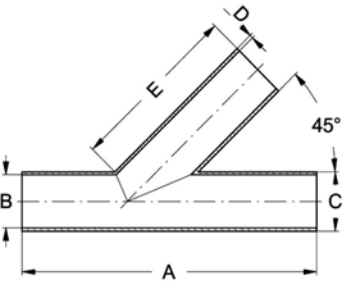
Rohrkupplungen und Fittings							Art.No.	EUR	Art.No.	EUR
<b>Abzweigstück 45°</b> <b>Branch piece 45°</b> 	DN	A	B	C	D	E			AISI304	
	101,6x2	450	97,6	101,6	2	321			573434	164,80
	104x2	500	100	104	2	300			573435	165,10
	129x2	600	125	129	2	352			573445	241,20

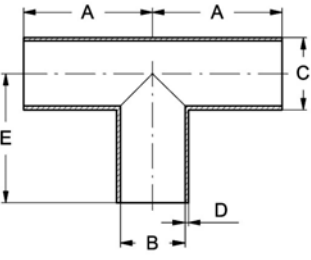
<b>T-Stück</b> <b>T-piece</b> 	DN	A	B	C	D	E			AISI304	
	38x1,5	125	35	38	1,5	1143			573502	41,70
	40x1,5	125	37	40	1,5	144			573504	44,90
	45x1,5	125	42	45	1,5	147,5			573507	45,40
	50x1,5	125	47	50	1,5	149			573509	46,30
	54x2	125	50	54	2	152			573511	54,40
	60,3x2	130	56,3	60,3	2	154			573515	62,70
	65x2	150	61	65	2	152,5			573517	71,40
	70x2	150	66	70	2	155			573520	73,30
	76,1x2	150	72,1	76,1	2	158			573524	74,50
	80x2	175	76	80	2	189			573525	84,80
	84x2	150	80	84	2	191			573527	88,20
	88,9x2	150	84,9	88,9	2	194,5			573530	90,70
	100x1,5	175	97	100	1,5	200			573533	Anfrage
	101,6x2	175	97,6	101,6	2	201			573534	113,50
	104x2	175	100	104	2	201			573535	114,60
129x2	225	125	129	2	244,5			573545	172,90	