

Gewindefittings Threaded fittings

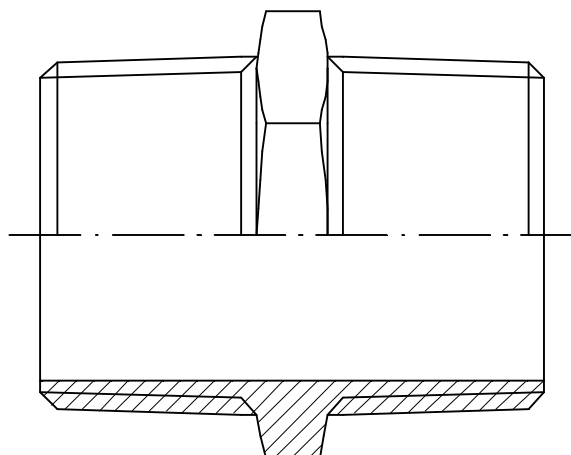

Einsatzgebiete

Die Gewindefittings werden bei vielen verfahrenstechnischen Anlagen für gasförmige und flüssige Medien zum einfachen Anschluss und Verbinden von Rohrleitungsteilen eingesetzt.

Ausführung

Die Gewindefittings werden üblicherweise aus Edelstahlfeinguss hergestellt. Aus Rohren, Stab- oder Hohlstahl gefertigte Gewindefittings sind auf Anfrage lieferbar. Standardmäßig sind die Gewindefittings mit Whitworth-Rohrgewinden DIN 2999 bzw. EN 10266-1 ausgestattet. Hierbei handelt es sich um eine gewindedichtende Verbindung. Die Innengewinde Rp sind zylindrisch und entsprechen den Innengewinden G nach ISO 228-1, die Außengewinde R sind konisch. Darüberhinaus werden Gewindefittings mit zylindrischem G-Gewinde gemäß ISO 228-1 angeboten. Andere Gewinde wie z.B. NPT-Gewinde sind auf Anfrage lieferbar.

Merkmale

- Größen: DN6 bis DN150
- Material: AISI304, 316, 316C, 316L, 316Ti

Application

The threaded fittings are used with process engineering facilities for gaseous and liquid media for easy connection of piping components.

Design

The threaded fittings are usually made of stainless steel investment castings. Fittings made of tubes, hollow steel or bars are available on request. Normally the fittings have Whitworth pipe threads according to DIN 2999 or EN 10266-1. It is a thread-sealing connection. The internal threads Rp are cylindrical and correspond with the internal threads G according to ISO 228-1, the external threads R are conical. In addition, threaded fittings with G-threads according to ISO 228-1 are offered. Other threads e.g. NPT threads are available upon request.

Features

- Sizes: DN6 up to DN150
- Material: AISI304, 316, 316C, 316L, 316Ti

Artikel	Seite
Anschweißmuffen	250
Muffen	250
Halbmuffen	250
Reduziermuffen	251
Anschweißnippel	251
Sechskant-Anschweißnippel	252
Rohrnippel	252
Rohrdoppelnippel	252
Sechskantdoppelnippel	253
Sechskant-Reduzierdoppelnippel	253
Sechskant-Reduzierstücke	254
Sechskant-Gewindeschlauchtüllen	254
Gewindeschlauchnippel	255
Anschweißschlauchnippel	255
Vierkantstopfen	255
Sechskantstopfen	255
Verschlussschrauben	256
Sechskantkappen	256
Sechskantmuttern	257
Bogen	257
Winkel	257
T-Stücke	259
Kreuzstücke	259
Verschraubungen	260

Articles	Page
Welding sockets	250
Sockets	250
Half sockets	250
Reducing sockets	251
Welding nipples	251
Welding nipples, hexagonal	252
Tube nipples	252
Tube double nipples	252
Double nipples hexagonal	253
Reducing double nipples hexagonal	253
Reducing pieces hexagonal	254
Hose nozzles, hexagon, thread	254
Hose nozzles, thread	255
Hose nozzles for welding	255
Plug square	255
Plug hexagonal	255
Screw plug	256
Cap hexagonal	256
Nuts hexagonal	257
Bends	257
Angles	257
T-pieces	259
Cross pieces	259
Unions	260

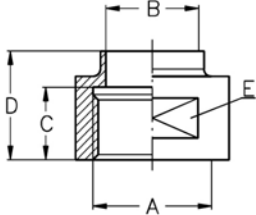
Gewindefittings							Art.No.	EUR	Art.No.	EUR
Anschweißmuffe, Rp Welding socket, Rp 	DN	A	B	C	D	E	AISI304		AISI316L	
	10	Rp 3/8"	10	12	20	SW 19	540130	20,80	540230	Anfrage
	15	Rp 1/2"	16	15	25	SW 24	540131	21,20	540231	Anfrage
	20	Rp 3/4"	20	15	25	SW 30	540132	21,90	540232	Anfrage
	25	Rp 1"	26	20	30	SW 41	540133	25,30	540233	Anfrage
	32	Rp 1,25"	32	20	30	SW 46	540134	31,40	540234	Anfrage
	40	Rp 1,5"	38	20	30	SW 50	540135	37,10	540235	Anfrage
	50	Rp 2"	50	20	32	SW 65	540136	47,70	540236	Anfrage
	65	Rp 2,5"	66	22	32	SW 80	540137	55,40	540237	Anfrage
	80	Rp 3"	81	25	37	SW 95	540138	65,00	540238	Anfrage
100	Rp 4"	100	30	45	SW 117	540139	Anfrage	540239	Anfrage	

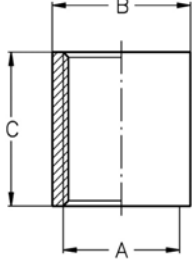
Muffe, Rp Socket, Rp 	DN	A	B	C				AISI316Ti		
	6	Rp 1/8"	14	17					540428	6,10
	8	Rp 1/4"	17,5	25					540429	5,40
	10	Rp 3/8"	21,3	26					540430	6,60
	15	Rp 1/2"	26,4	34					540431	8,70
	20	Rp 3/4"	31,8	36					540432	10,40
	25	Rp 1"	39,5	43					540433	15,50
	32	Rp 1,25"	48,3	48					540434	19,40
	40	Rp 1,5"	54,5	48					540435	24,80
	50	Rp 2"	66,3	56					540436	33,50
	65	Rp 2,5"	82	65					540437	75,40
	80	Rp 3"	95	71					540438	102,40
	100	Rp 4"	122	83					540439	153,10
	125	Rp 5"	150	92					540441	Anfrage
150	Rp 6"	180	92					540442	Anfrage	

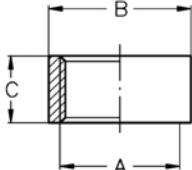
Halbmuffe, Rp Half socket, Rp 	DN	A	B	C				AISI316Ti		
	6	Rp 1/8"	14	7,5					540628	3,80
	8	Rp 1/4"	17,5	11					540629	3,90
	10	Rp 3/8"	21,3	11,5					540630	4,10
	15	Rp 1/2"	26,4	15					540631	4,50
	20	Rp 3/4"	31,8	16,5					540632	5,70
	25	Rp 1"	39,5	19					540633	8,20
	32	Rp 1,25"	48,3	21,5					540634	11,80
	40	Rp 1,5"	54,5	21,5					540635	13,60
	50	Rp 2"	66,3	26					540636	19,40
	65	Rp 2,5"	82	30					540637	43,50
	80	Rp 3"	95	33					540638	51,40
	100	Rp 4"	122	39					540639	118,30
	125	Rp 5"	150	44					540641	Anfrage
150	Rp 6"	180	44					540642	Anfrage	

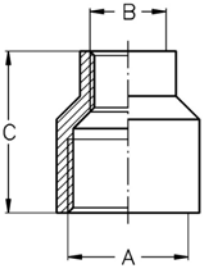
Gewindefittings						Art.No.	EUR	Art.No.	EUR
Reduziermuffe, Rp Reducing socket, Rp 	DN	A	B	C				AISI316C-1.4408	
	8-6	Rp 1/4"	Rp 1/8"	26				540729	10,20
	10-8	Rp 3/8"	Rp 1/4"	29				540730	10,70
	10-6	Rp 3/8"	Rp 1/8"	30				540799	10,70
	15-8	Rp 1/2"	Rp 1/4"	33				540731	12,50
	15-10	Rp 1/2"	Rp 3/8"	34				540759	12,50
	20-10	Rp 3/4"	Rp 3/8"	36,5				540760	19,30
	20-15	Rp 3/4"	Rp 1/2"	36,5				540761	19,30
	25-15	Rp 1"	Rp 1/2"	42,8				540763	28,40
	25-20	Rp 1"	Rp 3/4"	42				540764	28,40
	32-20	Rp 1,25"	Rp 3/4"	48,5				540766	46,80
	32-25	Rp 1,25"	Rp 1"	52				540767	46,80
	40-25	Rp 1,5"	Rp 1"	53				540770	50,60
	40-32	Rp 1,5"	Rp 1,25"	53				540771	50,60
	50-32	Rp 2"	Rp 1,25"	56				540773	71,10
	50-40	Rp 2"	Rp 1,5"	57				540774	71,10
	65-40	Rp 2,5"	Rp 1,5"	60				540777	213,60
	65-50	Rp 2,5"	Rp 2"	60,8				540778	213,60
	80-50	Rp 3"	Rp 2"	62				540782	302,90
80-65	Rp 3"	Rp 2,5"	62				540783	302,80	

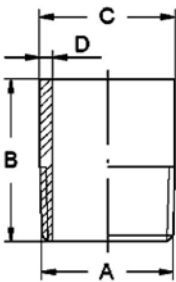
Anschweißnippel, R Welding nipple, R 	DN	A	B	C	D			AISI316Ti	
	6	R 1/8"	30	10,2	2			540928	4,80
	8	R 1/4"	30	13,5	2,3			540929	4,80
	10	R 3/8"	30	17,2	2,3			540930	4,80
	15	R 1/2"	35	21,3	2,6			540931	5,20
	20	R 3/4"	40	26,9	2,6			540932	6,10
	25	R 1"	40	33,7	3,2			540933	9,20
	32	R 1,25"	50	42,4	3,2			540934	12,80
	40	R 1,5"	50	48,3	3,2			540935	15,10
	50	R 2"	50	60,3	3,6			540936	20,60
	65	R 2,5"	60	76,1	3,6			540937	32,30
	80	R 3"	70	88,9	4			540938	41,40
	100	R 4"	80	114,3	4,5			540939	76,30
	125	R 5"	90	139,7	5			540941	Anfrage
	150	R 6"	120	168,3	7,1			540942	Anfrage

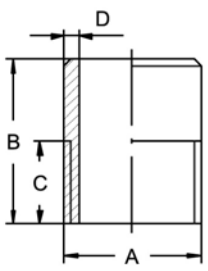
Anschweißnippel, G Welding nipple, G 	DN	A	B	C	D			AISI316Ti	
	15	G 1/2"	40	20	3,2			544631	7,40
	20	G 3/4"	40	20	3,2			544632	9,20
	25	G 1"	40	20	3,2			544633	13,60
	32	G 1,25"	40	20	4,05			544634	19,30
	40	G 1,5"	45	25	4,5			544635	22,30
	50	G 2"	45	25	5,54			544636	29,80
	65	G 2,5"	45	25	5			544637	48,60
	80	G 3"	45	25	5,49			544638	61,40
100	G 4"	45	25	5,4			544639	115,20	

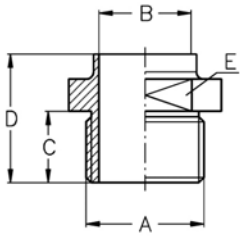
Gewindefittings							Art.No.	EUR	Art.No.	EUR
Anschweißnippel mit Schlüsselfläche, G Welding nipple with spanner flat, G 	DN	A	B	C	D	E	AISI304		AISI316L	
	10	G 3/8"	10	12	20	SW 19	541030	19,80	541130	Anfrage
	15	G 1/2"	16	15	25	SW 24	541031	20,70	541131	Anfrage
	20	G 3/4"	20	15	25	SW 30	541032	22,20	541132	Anfrage
	25	G 1"	26	20	30	SW 41	541033	35,90	541133	Anfrage
	32	G 1,25"	32	20	30	SW 46	541034	39,90	541134	Anfrage
	40	G 1,5"	38	20	30	SW 50	541035	31,30	541135	Anfrage
	50	G 2"	50	20	32	SW 65	541036	40,80	541136	Anfrage
	65	G 2,5"	66	22	32	SW 80	541037	50,50	541137	Anfrage
	80	G 3"	81	25	37	SW 95	541038	68,10	541138	Anfrage
100	G 4"	100	30	45	SW 117	541039	Anfrage	541139	Anfrage	

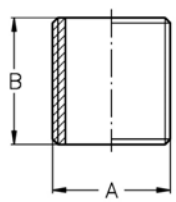
Rohrnippel, G Tube nipple, G 	DN	A	B					AISI316Ti		
	6	G 1/8"	16						541228	5,70
	8	G 1/4"	18						541229	5,70
	10	G 3/8"	22						541230	5,70
	15	G 1/2"	25						541231	7,10
	20	G 3/4"	30						541232	8,80
	25	G 1"	35						541233	10,70
	32	G 1,25"	38						541234	14,10
	40	G 1,5"	38						541235	17,40
	50	G 2"	45						541236	34,50
	65	G 2,5"	55						541237	31,80
	80	G 3"	60						541238	43,50
	100	G 4"	70						541239	86,70
	125	G 5"	85						541241	Anfrage
150	G 6"	100						541242	Anfrage	

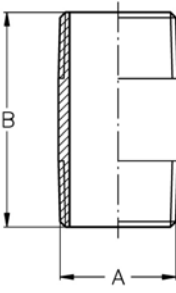
Rohrdoppelnippel, R Tube double nipple, R 	DN	A	B					AISI316Ti		
	6	R 1/8"	40						541428	10,30
	8	R 1/4"	40						541429	10,70
	10	R 3/8"	40						541430	6,10
	15	R 1/2"	60						541431	7,60
	20	R 3/4"	60						541432	8,80
	25	R 1"	60						541433	12,30
	32	R 1,25"	80						541434	19,40
	40	R 1,5"	80						541435	21,30
	50	R 2"	100						541436	31,80
	65	R 2,5"	100						541437	47,80
	80	R 3"	120						541438	59,70
	100	R 4"	120						541439	89,10
	125	R 5"	150						541441	Anfrage

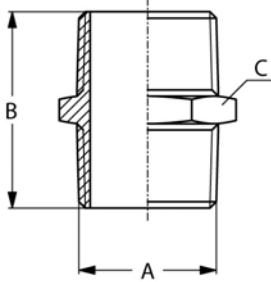
Gewindefittings							Art.No.	EUR	Art.No.	EUR	
Sechskant-Doppelnippel, R Double nipple hexagonal, R 	DN	A	B	C			AISI316C-1.4408				
	6	R 1/8"	23,6	SW 12				541528	8,80		
	8	R 1/4"	27,8	SW 16				541529	8,80		
	10	R 3/8"	28	SW 19				541530	9,60		
	15	R 1/2"	34	SW 21,6				541531	11,70		
	20	R 3/4"	40	SW 30				541532	14,50		
	25	R 1"	46	SW 36				541533	20,60		
	32	R 1,25"	52,5	SW 46				541534	32,40		
	40	R 1,5"	54	SW 50				541535	45,80		
	50	R 2"	62	SW 62,5				541536	68,40		
	65	R 2,5"	70	SW 80				541537	150,90		
	80	R 3"	78,4	SW 90				541538	217,50		
	100	R 4"	94	SW 120				541539	414,10		

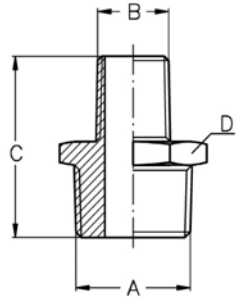
Sechskant-Reduzierdoppelnippel, R Red. double nipple hexagonal, R 	DN	A	B	C	D			AISI316C-1.4408		
	8-6	R 1/4"	R 1/8"	34	SW 18				541627	9,80
	10-6	R 3/8"	R 1/8"	34	SW 21				541628	10,60
	10-8	R 3/8"	R 1/4"	36	SW 21				541629	10,60
	15-6	R 1/2"	R 1/8"	34	SW 26				541630	14,10
	15-8	R 1/2"	R 1/4"	34	SW 26				541631	14,10
	15-10	R 1/2"	R 3/8"	41	SW 26				541659	14,10
	20-6	R 3/4"	R 1/8"	37	SW 30				541632	16,70
	20-8	R 3/4"	R 1/4"	37	SW 30				541633	16,70
	20-10	R 3/4"	R 3/8"	37	SW 30				541660	16,70
	20-15	R 3/4"	R 1/2"	45	SW 30				541661	16,70
	25-10	R 1"	R 3/8"	40	SW 35				541662	24,60
	25-15	R 1"	R 1/2"	43,2	SW 35				541663	24,60
	25-20	R 1"	R 3/4"	50	SW 37				541664	24,60
	32-15	R 1,25"	R 1/2"	48	SW 46				541665	40,20
	32-20	R 1,25"	R 3/4"	52	SW 46				541666	40,20
	32-25	R 1,25"	R 1"	54	SW 46				541667	40,20
	40-20	R 1,5"	R 3/4"	53	SW 50				541669	57,40
	40-25	R 1,5"	R 1"	53	SW 50				541670	57,40
	40-32	R 1,5"	R 1,25"	59	SW 50				541671	57,40
	50-20	R 2"	R 3/4"	56	SW 63				541636	81,80
	50-25	R 2"	R 1"	57	SW 63				541672	81,70
	50-32	R 2"	R 1,25"	58	SW 63				541673	81,70
	50-40	R 2"	R 1,5"	64	SW 64				541674	81,70
	65-32	R 2,5"	R 1,25"	66	SW 80				541676	156,90
	65-40	R 2,5"	R 1,5"	66	SW 80				541677	156,90
	65-50	R 2,5"	R 2"	77	SW 80				541678	156,90
	80-50	R 3"	R 2"	74	SW 95				541682	240,30
80-65	R 3"	R 2,5"	84	SW 95				541683	240,30	

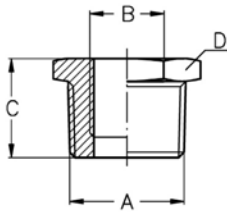
Gewindefittings							Art.No.	EUR	Art.No.	EUR
Sechskant-Reduzierstück, RRp Reducing piece hexagonal, RRp 	DN	A	B	C	D		AISI316C-1.4408			
	8-6	R 1/4"	Rp 1/8"	15,2	SW 16			541727	5,60	
	10-6	R 3/8"	Rp 1/8"	16,5	SW 18			541728	6,10	
	10-8	R 3/8"	Rp 1/4"	16,5	SW 18			541729	6,10	
	15-6	R 1/2"	Rp 1/8"	21	SW 26			541730	7,50	
	15-8	R 1/2"	Rp 1/4"	21	SW 26			541731	7,50	
	15-10	R 1/2"	Rp 3/8"	21	SW 26			541759	7,50	
	20-8	R 3/4"	Rp 1/4"	24	SW 30			541733	10,40	
	20-10	R 3/4"	Rp 3/8"	24	SW 30			541760	10,40	
	20-15	R 3/4"	Rp 1/2"	24	SW 30			541761	10,40	
	25-15	R 1"	Rp 1/2"	27	SW 35			541763	16,60	
	25-20	R 1"	Rp 3/4"	27	SW 35			541764	16,60	
	32-15	R 1,25"	Rp 1/2"	30	SW 45			541765	23,80	
	32-20	R 1,25"	Rp 3/4"	30	SW 45			541766	23,80	
	32-25	R 1,25"	Rp 1"	30	SW 45			541767	23,80	
	40-15	R 1,5"	Rp 1/2"	36	SW 52			541768	35,60	
	40-20	R 1,5"	Rp 3/4"	36	SW 52			541769	35,60	
	40-25	R 1,5"	Rp 1"	36	SW 52			541770	35,60	
	40-32	R 1,5"	Rp 1,25"	36	SW 52			541771	35,60	
	50-20	R 2"	Rp 3/4"	36	SW 63			541736	54,70	
	50-25	R 2"	Rp 1"	36	SW 63			541772	54,70	
	50-32	R 2"	Rp 1,25"	36	SW 63			541773	54,70	
	50-40	R 2"	Rp 1,5"	36	SW 63			541774	54,70	
	65-40	R 2,5"	Rp 1,5"	45	SW 81			541777	102,40	
	65-50	R 2,5"	Rp 2"	45	SW 81			541778	102,40	
	80-40	R 3"	Rp 1,5"	47	SW 95			541781	162,90	
	80-50	R 3"	Rp 2"	47	SW 95			541782	162,90	
	80-65	R 3"	Rp 2,5"	47	SW 95			541783	162,90	
100-50	R 4"	Rp 2"	52	SW 119			541784	308,10		
100-65	R 4"	Rp 2,5"	52	SW 119			541785	308,10		
100-80	R 4"	Rp 3"	52	SW 119			541786	308,10		

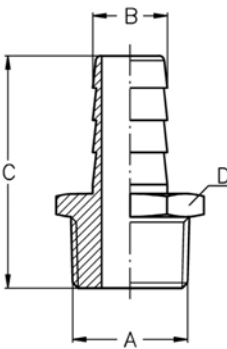
Sechskant-Gewindeschlauchtülle, R Hose nozzle, hexagon, thread, R 	DN	A	B	C	D		AISI316C-1.4408			
	6	R 1/8"	7	45	SW 12			541828	23,40	
	8	R 1/4"	9	47	SW 16			541829	25,10	
	10	R 3/8"	11	55	SW 20			541830	26,10	
	15	R 1/2"	14	64	SW 23			541831	29,70	
	20	R 3/4"	20	68	SW 31			541832	34,30	
	25	R 1"	26	71	SW 38			541833	41,90	
	32	R 1,25"	33	80	SW 46			541834	76,80	
	40	R 1,5"	39	95	SW 52			541835	89,10	
	50	R 2"	51	105	SW 62			541836	181,90	
	65	R 2,5"	63	107	SW 80			541837	261,90	
	80	R 3"	76	112	SW 91			541838	368,40	

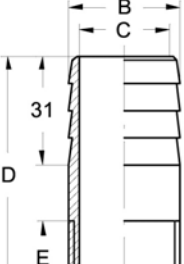
Gewindefittings							Art.No.	EUR	Art.No.	EUR
Gewindeschlauchnippel, R Hose nozzle, thread, R 	DN	A	B	C	D	E			AISI316Ti	
	8	R 1/4"	13,5	8,9	70	13			543829	13,60
	10	R 3/8"	17,2	12,6	70	15			543830	13,90
	15	R 1/2"	21,3	16,1	70	15			543831	15,40
	20	R 3/4"	26,9	21,7	70	18			543832	17,90
	25	R 1"	33,7	27,3	70	21			543833	20,90
	32	R 1,25"	42,4	36	70	23			543834	27,90
	40	R 1,5"	48,3	41,9	100	23			543835	33,30
	50	R 2"	60,3	53,1	100	23			543836	50,80

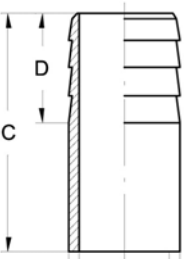
Anschweißschlauchnippel Hose nozzle for welding 	DN	A	B	C	D			AISI316Ti	
	8	13,5	8,9	70	31			541929	9,10
	10	17,2	12,6	70	31			541930	9,60
	15	21,3	16,1	70	31			541931	10,40
	20	26,9	21,7	70	31			541932	12,20
	25	33,7	27,3	70	31			541933	13,60
	32	42,4	36	70	31			541934	18,10
	40	48,3	41,9	100	31			541935	20,30
	50	60,3	53,1	100	31			541936	31,40

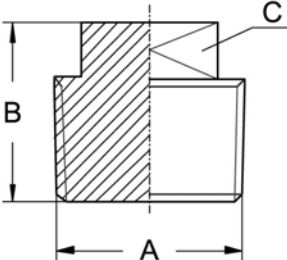
Vierkantstopfen, R Plug square, R 	DN	A	B	C			AISI316C-1.4408		
	6	R 1/8"	19	SW 6				543928	5,90
	8	R 1/4"	20	SW 9				543929	6,60
	10	R 3/8"	22	SW 11				543930	6,80
	15	R 1/2"	25	SW 13				543931	7,30
	20	R 3/4"	27	SW 16				543932	9,20
	25	R 1"	32	SW 20				543933	15,40
	32	R 1,25"	35	SW 24				543934	25,80
	40	R 1,5"	37	SW 25				543935	28,90
	50	R 2"	38	SW 32				543936	45,50
	65	R 2,5"	48	SW 42				543937	112,20
	80	R 3"	52	SW 46				543938	175,10
100	R 4"	62	SW 58				543939	Anfrage	

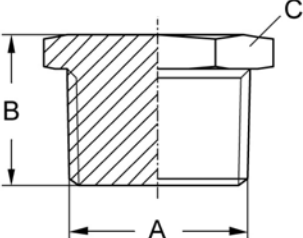
Sechskantstopfen, R Plug hexagonal, R 	DN	A	B	C			AISI316C-1.4408		
	6	R 1/8"	17	SW 12				542028	6,60
	8	R 1/4"	17,5	SW 16				542029	6,90
	10	R 3/8"	18	SW 20				542030	7,30
	15	R 1/2"	25	SW 24				542031	8,50
	20	R 3/4"	26	SW 30				542032	11,10
	25	R 1"	29	SW 38				542033	18,80
	32	R 1,25"	35	SW 46				542034	25,60
	40	R 1,5"	38	SW 52				542035	38,30
	50	R 2"	39	SW 65				542036	41,90

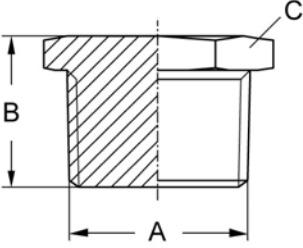
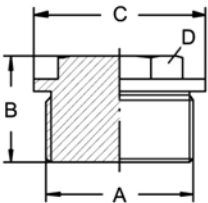
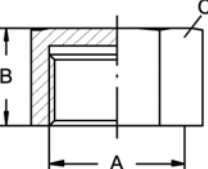
Gewindefittings							Art.No.	EUR	Art.No.	EUR
Sechskantstopfen, R Plug hexagonal, R 	DN	A	B	C					AISI316C-1.4408	
	65	R 2,5"	44	SW 81					542037	106,60
	80	R 3"	54	SW 94					542038	160,40
	100	R 4"	55	SW 119					542039	344,80
Verschlusschraube, G Screw plug, G 	DN	A	B	C	D				AISI316Ti	
	6	G 1/8"	17	14	SW 10				544028	11,40
	8	G 1/4"	21	18	SW 13				544029	11,90
	10	G 3/8"	21	22	SW 17				544030	14,80
	15	G 1/2"	26	26	SW 19				544031	17,60
	20	G 3/4"	30	32	SW 24				544032	19,50
	25	G 1"	32	39	SW 27				544033	30,70
	32	G 1,25"	33	49	SW 30				544034	61,60
	40	G 1,5"	33	55	SW 30				544035	73,10
	50	G 2"	40	72	SW 36				544036	100,30
	65	G 2,5"	50	75	SW 46				544037	123,80
	80	G 3"	55	95	SW 50				544038	150,60
Sechskantkappe, Rp Cap hexagonal, Rp 	DN	A	B	C					AISI316C-1.4408	
	6	Rp 1/8"	13	SW 15					542128	6,10
	8	Rp 1/4"	17	SW 18					542129	6,40
	10	Rp 3/8"	19	SW 21					542130	6,70
	15	Rp 1/2"	20	SW 27					542131	8,30
	20	Rp 3/4"	24	SW 30					542132	11,80
	25	Rp 1"	25	SW 38					542133	17,40
	32	Rp 1,25"	28	SW 50					542134	25,70
	40	Rp 1,5"	28	SW 55					542135	33,40
	50	Rp 2"	34	SW 70					542136	51,30
	65	Rp 2,5"	40	SW 92					542137	91,50
	80	Rp 3"	45	SW 109					542138	122,30
100	Rp 4"	50	SW 132					542139	206,20	

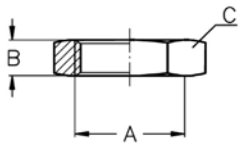
Gewindefittings						Art.No.	EUR	Art.No.	EUR
Sechskantmutter, G Nut hexagonal, G 	DN	A	B	C			AISI316Ti		
	6	R 1/8"	6	SW 19			542228	5,60	
	8	R 1/4"	6	SW 22			542229	6,70	
	10	R 3/8"	7	SW 27			542230	7,30	
	15	R 1/2"	8	SW 32			542231	7,60	
	20	R 3/4"	9	SW 36			542232	9,30	
	25	R 1"	10	SW 46			542233	14,20	
	32	R 1,25"	11	SW 55			542234	18,60	
	40	R 1,5"	12	SW 60			542235	24,10	
	50	R 2"	13	SW 75			542236	44,90	
	65	R 2,5"	16	SW 95			542237	76,40	
	80	R 3"	19	SW 105			542238	93,10	
100	R 4"	21	SW 135			542239	125,80		

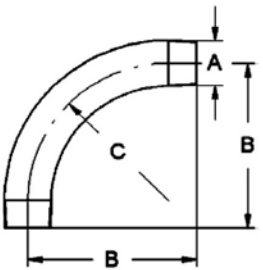
Bogen 90°, R Bend 90°, R 	DN	A	B	C			AISI316Ti	
	6	R 1/8"	50	30			542328	22,10
	8	R 1/4"	60	40			542329	22,10
	10	R 3/8"	70	45			542330	22,10
	15	R 1/2"	95	55			542331	22,10
	20	R 3/4"	100	70			542332	31,40
	25	R 1"	120	80			542333	51,80
	32	R 1,25"	140	105			542334	80,10
	40	R 1,5"	160	115			542335	109,80
	50	R 2"	190	125			542336	162,70
	65	R 2,5"	240	170			542337	190,90
	80	R 3"	290	200			542338	Anfrage
100	R 4"	375	300			542339	Anfrage	

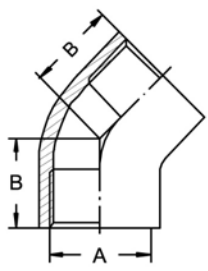
Winkel 45°, Rp Angle 45°, Rp 	DN	A	B				AISI316C-1.4408	
	6	Rp 1/8"	17,5				544128	Anfrage
	8	Rp 1/4"	19,4				544129	17,80
	10	Rp 3/8"	20,7				544130	18,40
	15	Rp 1/2"	22				544131	19,30
	20	Rp 3/4"	25				544132	28,90
	25	Rp 1"	29				544133	38,30
	32	Rp 1,25"	33				544134	56,50
	40	Rp 1,5"	36				544135	63,40
	50	Rp 2"	43				544136	80,70
	65	Rp 2,5"	48,5				544137	229,10
	80	Rp 3"	53,8				544138	291,30
100	Rp 4"	64,7				544139	Anfrage	

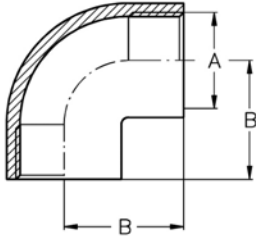
Gewindefittings						Art.No.	EUR	Art.No.	EUR
Winkel 90°, Rp Angle 90°, Rp 	DN	A	B					AISI316C-1.4408	
	6	R 1/8"	17,6					542428	11,70
	8	R 1/4"	20					542429	11,10
	10	R 3/8"	21,3					542430	11,10
	15	R 1/2"	27					542431	11,70
	20	R 3/4"	33					542432	18,60
	25	R 1"	38					542433	21,90
	32	R 1,25"	45					542434	33,40
	40	R 1,5"	50					542435	40,20
	50	R 2"	58					542436	57,60
	65	R 2,5"	69,3					542437	158,90
	80	R 3"	77,5					542438	209,80
	100	R 4"	97,3					542439	381,90

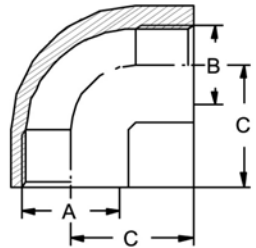
Reduzierwinkel 90°, Rp Reducing angle 90°, Rp 	DN	A	B	C				AISI316C-1.4408	
	10-8	Rp 3/8"	Rp 1/4"	25				544229	15,30
	15-8	Rp 1/2"	Rp 1/4"	28				544231	Anfrage
	15-10	Rp 1/2"	Rp 3/8"	28				544259	17,40
	20-10	Rp 3/4"	Rp 3/8"	33				544260	Anfrage
	20-15	Rp 3/4"	Rp 1/2"	33				544261	26,20
	25-15	Rp 1"	Rp 1/2"	38				544263	Anfrage
	25-20	Rp 1"	Rp 3/4"	38				544264	34,90
	32-20	Rp 1,25"	Rp 3/4"	45				544266	Anfrage
	32-25	Rp 1,25"	Rp 1"	45				544267	51,30
	40-25	Rp 1,5"	Rp 1"	50				544270	Anfrage
	40-32	Rp 1,5"	Rp 1,25"	50				544271	68,20
	50-32	Rp 2"	Rp 1,25"	58				544273	Anfrage
50-40	Rp 2"	Rp 1,5"	58				544274	100,40	

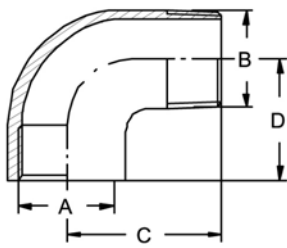
Winkel 90°, RpR Angle 90°, RpR 	DN	A	B	C	D			AISI316C-1.4408	
	6	Rp 1/8"	R 1/8"	26	19			544328	17,50
	8	Rp 1/4"	R 1/4"	28,3	19			544329	18,70
	10	Rp 3/8"	R 3/8"	35	22,5			544330	19,40
	15	Rp 1/2"	R 1/2"	42	29			544331	22,90
	20	Rp 3/4"	R 3/4"	50,5	33			544332	33,80
	25	Rp 1"	R 1"	52	38			544333	45,40
	32	Rp 1,25"	R 1,25"	60	45			544334	67,10
	40	Rp 1,5"	R 1,5"	65	50			544335	81,60
	50	Rp 2"	R 2"	74	58			544336	120,20
	65	Rp 2,5"	R 2,5"	99,5	68			544337	191,40
	80	Rp 3"	R 3"	115,5	78			544338	285,30

Gewindefittings							Art.No.	EUR	Art.No.	EUR	
T-Stück, Rp T-piece, Rp 	DN	A	B				AISI316C-1.4408				
	6	Rp 1/8"	17					542528	14,90		
	8	Rp 1/4"	21					542529	14,90		
	10	Rp 3/8"	23,6					542530	17,40		
	15	Rp 1/2"	27					542531	17,90		
	20	Rp 3/4"	33					542532	20,20		
	25	Rp 1"	38					542533	31,30		
	32	Rp 1,25"	45					542534	44,90		
	40	Rp 1,5"	50					542535	48,80		
	50	Rp 2"	58					542536	81,20		
	65	Rp 2,5"	68,7					542537	188,80		
	80	Rp 3"	77,8					542538	254,00		
	100	Rp 4"	97					542539	500,70		

Reduzier T-Stück, Rp							AISI316C-1.4408	
DN	A	B	C					
10-8	Rp 3/8"	Rp 1/4"	25				544429	19,80
15-8	Rp 1/2"	Rp 1/4"	28				544431	Anfrage
15-10	Rp 1/2"	Rp 3/8"	28				544459	22,40
20-10	Rp 3/4"	Rp 3/8"	32				544460	Anfrage
20-15	Rp 3/4"	Rp 1/2"	32				544461	27,50
25-15	Rp 1"	Rp 1/2"	38				544463	24,90
25-20	Rp 1"	Rp 3/4"	38				544464	42,80
32-20	Rp 1,25"	Rp 3/4"	40				544466	Anfrage
32-25	Rp 1,25"	Rp 1"	40				544467	61,40
40-25	Rp 1,5"	Rp 1"	45				544470	Anfrage
40-32	Rp 1,5"	Rp 1,25"	45				544471	80,70
50-32	Rp 2"	Rp 1,25"	52				544473	Anfrage
50-40	Rp 2"	Rp 1,5"	52				544474	120,80

Kreuzstück, Rp							AISI316C-1.4408	
DN	A	B						
6	Rp 1/8"	17					544528	45,90
8	Rp 1/4"	19					544529	36,70
10	Rp 3/8"	22,9					544530	38,40
15	Rp 1/2"	26,8					544531	45,90
20	Rp 3/4"	32					544532	54,10
25	Rp 1"	37,5					544533	62,60
32	Rp 1,25"	45,9					544534	93,40
40	Rp 1,5"	47,6					544535	110,10
50	Rp 2"	56,3					544536	155,50
65	Rp 2,5"	69					544537	412,60
80	Rp 3"	78					544538	593,80

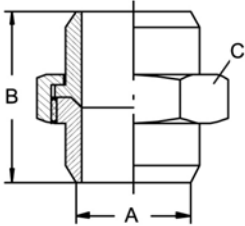
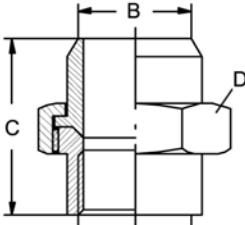
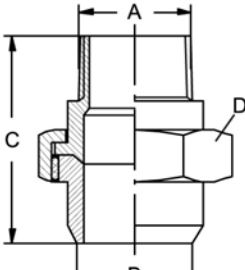
Gewindefittings							Art.No.	EUR	Art.No.	EUR
Verschraubung konisch, SS Union conical, SS 	DN	A	B	C					AISI316C-1.4408	
	6	10,2	37	SW 30					543328	33,80
	8	13,2	37	SW 30					543329	39,50
	10	17,2	40	SW 36					543330	30,60
	15	21,3	46	SW 41					543331	33,40
	20	26,9	48	SW 46					543332	44,70
	25	33,7	52	SW 50					543333	58,40
	32	42,4	60	SW 65					543334	82,80
	40	48,3	71	SW 75					543335	100,60
	50	60,3	76	SW 90					543336	135,30
	65	76,1	90	SW 110					543337	355,70
	80	88,9	90	SW 120					543338	474,50
100	114,3	115	SW 155					543339	820,70	
Verschraubung konisch, RpS Union conical, RpS 	DN	A	B	C	D				AISI316C-1.4408	
	6	Rp 1/8"	10,2	37	SW 30				543428	Anfrage
	8	Rp 1/4"	13,2	37	SW 30				543429	58,60
	10	Rp 3/8"	17,2	40	SW 36				543430	58,60
	15	Rp 1/2"	21,3	46	SW 41				543431	67,10
	20	Rp 3/4"	26,9	48	SW 46				543432	87,90
	25	Rp 1"	33,7	52	SW 50				543433	116,50
	32	Rp 1,25"	42,4	60	SW 65				543434	166,60
	40	Rp 1,5"	48,3	71	SW 75				543435	202,40
	50	Rp 2"	60,3	76	SW 90				543436	269,80
	65	Rp 2,5"	76,1	90	SW 110				543437	712,60
	80	Rp 3"	88,9	90	SW 120				543438	918,70
Verschraubung konisch, RS Union conical, RS 	DN	A	B	C	D				AISI316C-1.4408	
	8	R 1/4"	13,2	50	SW 30				543529	66,30
	10	R 3/8"	17,2	52	SW 36				543530	66,30
	15	R 1/2"	21,3	62	SW 41				543531	74,50
	20	R 3/4"	26,9	65	SW 46				543532	97,80
	25	R 1"	33,7	71	SW 50				543533	126,90
	32	R 1,25"	42,4	81	SW 65				543534	175,80
	40	R 1,5"	48,3	95	SW 75				543535	225,20
	50	R 2"	60,3	102	SW 90				543536	306,90
	65	R 2,5"	76,1	121	SW 110				543537	731,80
	80	R 3"	88,9	125	SW 120				543538	950,60

Gewindefittings							Art.No.	EUR	Art.No.	EUR
Verschraubung konisch, Rp Union conical, Rp 	DN	A	B	C			AISI316C-1.4408			
	6	Rp 1/8"	37	SW 30				543628	33,80	
	8	Rp 1/4"	37	SW 30				543629	29,30	
	10	Rp 3/8"	40	SW 36				543630	30,60	
	15	Rp 1/2"	46	SW 41				543631	33,40	
	20	Rp 3/4"	48	SW 46				543632	44,50	
	25	Rp 1"	52	SW 50				543633	58,40	
	32	Rp 1,25"	60	SW 65				543634	82,80	
	40	Rp 1,5"	71	SW 75				543635	101,40	
	50	Rp 2"	76	SW 90				543636	135,20	
	65	Rp 2,5"	90	SW 110				543637	355,70	
	80	Rp 3"	90	SW 120				543638	474,80	
100	Rp 4"	115	SW 155				543639	820,70		

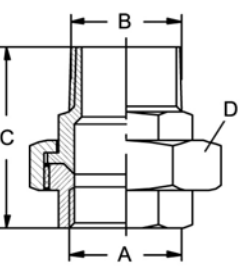
Verschraubung konisch, RpR Union conical, RpR 	DN	A	B	C	D		AISI316C-1.4408			
	8	Rp 1/4"	R 1/4"	50	SW 30			542629	36,60	
	10	Rp 3/8"	R 3/8"	52	SW 36			542630	38,20	
	15	Rp 1/2"	R 1/2"	62	SW 41			542631	41,10	
	20	Rp 3/4"	R 3/4"	65	SW 46			542632	53,20	
	25	Rp 1"	R 1"	71	SW 50			542633	67,40	
	32	Rp 1,25"	R 1,25"	81	SW 65			542634	92,80	
	40	Rp 1,5"	R 1,5"	95	SW 75			542635	125,30	
	50	Rp 2"	R 2"	102	SW 90			542636	170,20	
	65	Rp 2,5"	R 2,5"	121	SW 110			542637	374,80	
	80	Rp 3"	R 3"	125	SW 120			542638	496,90	
	100	Rp 4"	R 4"	155	SW 155			542639	830,40	

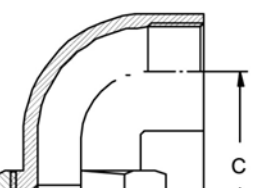
Winkelverschraubung konisch, Rp Angle union conical, Rp 	DN	A	B	C			AISI316C-1.4408			
	15	Rp 1/2"	26	49,1				543731	41,20	
	20	Rp 3/4"	30	55,1				543732	53,10	
	25	Rp 1"	35	63,1				543733	68,10	
	32	Rp 1,25"	42	73,6				543734	93,10	
	40	Rp 1,5"	45	79,6				543735	125,40	
50	Rp 2"	53	89,7				543736	171,50		

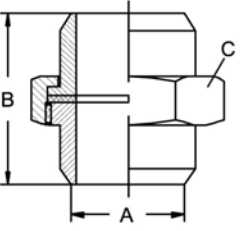
Gewindefittings						Art.No.	EUR	Art.No.	EUR
Verschraubung mit Dichtung, SS Union with washer, SS 	DN	A	B	C				AISI316C-PTFE	
	6	10,2	37	SW 30				542828	33,90
	8	13,2	37	SW 30				542829	29,20
	10	17,2	40	SW 36				542830	30,60
	15	21,3	46	SW 41				542831	34,80
	20	26,9	48	SW 46				542832	44,60
	25	33,7	52	SW 50				542833	60,50
	32	42,4	60	SW 65				542834	83,70
	40	48,3	71	SW 75				542835	101,20
	50	60,3	76	SW 90				542836	135,40
	65	76,1	90	SW 110				542837	355,80
	80	88,9	90	SW 120				542838	474,70
100	114,3	115	SW 155				542839	820,60	

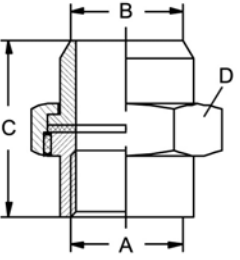
Verschraubung mit Dichtung, RpS Union with washer, RpS 	DN	A	B	C	D			AISI316C-PTFE	
	8	Rp 1/4"	13,2	37	SW 30			542929	58,70
	10	Rp 3/8"	17,2	40	SW 36			542930	58,70
	15	Rp 1/2"	21,3	46	SW 41			542931	66,90
	20	Rp 3/4"	26,9	48	SW 46			542932	88,30
	25	Rp 1"	33,7	52	SW 50			542933	116,10
	32	Rp 1,25"	42,4	60	SW 65			542934	166,20
	40	Rp 1,5"	48,3	71	SW 75			542935	203,50
	50	Rp 2"	60,3	76	SW 90			542936	270,60
	65	Rp 2,5"	76,1	90	SW 110			542937	713,90
80	Rp 3"	88,9	90	SW 120			542938	920,10	

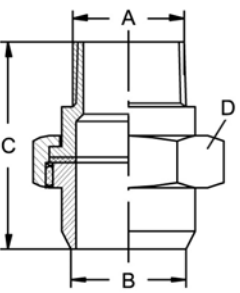
Verschraubung mit Dichtung, RS Union with washer, RS 	DN	A	B	C	D			AISI316C-PTFE	
	8	R 1/4"	13,2	50	SW 30			543029	67,10
	10	R 3/8"	17,2	52	SW 36			543030	67,10
	15	R 1/2"	21,3	62	SW 41			543031	74,70
	20	R 3/4"	26,9	65	SW 46			543032	97,80
	25	R 1"	33,7	73	SW 50			543033	126,90
	32	R 1,25"	42,4	83	SW 65			543034	175,80
	40	R 1,5"	48,3	90	SW 75			543035	226,60
	50	R 2"	60,3	102	SW 90			543036	306,50
	65	R 2,5"	76,1	121	SW 110			543037	732,80
80	R 3"	88,9	134	SW 120			543038	952,70	

Gewindefittings							Art.No.	EUR	Art.No.	EUR	
Verschraubung mit Dichtung, Rp Union with washer, Rp 	DN	A	B	C			AISI316C-PTFE				
	6	Rp 1/8"	29	SW 25				542728	33,90		
	8	Rp 1/4"	38	SW 30				542729	29,30		
	10	Rp 3/8"	38	SW 35				542730	30,40		
	15	Rp 1/2"	41	SW 42				542731	33,50		
	20	Rp 3/4"	50,4	SW 47				542732	44,60		
	25	Rp 1"	48	SW 53				542733	58,30		
	32	Rp 1,25"	59	SW 71				542734	83,20		
	40	Rp 1,5"	64	SW 78				542735	101,40		
	50	Rp 2"	69	SW 92				542736	135,30		
	65	Rp 2,5"	80	SW 112				542737	356,60		
	80	Rp 3"	88	SW 126				542738	474,80		
	100	Rp 4"	108	SW 157				542739	821,50		

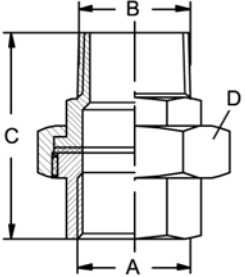
Verschraubung mit Dichtung, RpR Union with washer, RpR 	DN	A	B	C	D			AISI316C-PTFE		
	6	Rp 1/8"	R 1/8"	48	SW 25			543128	41,20	
	8	Rp 1/4"	R 1/4"	50	SW 30			543129	36,80	
	10	Rp 3/8"	R 3/8"	52	SW 36			543130	38,20	
	15	Rp 1/2"	R 1/2"	62	SW 41			543131	41,60	
	20	Rp 3/4"	R 3/4"	65	SW 46			543132	53,10	
	25	Rp 1"	R 1"	71	SW 50			543133	69,20	
	32	Rp 1,25"	R 1,25"	81	SW 65			543134	92,90	
	40	Rp 1,5"	R 1,5"	95	SW 75			543135	125,60	
	50	Rp 2"	R 2"	102	SW 90			543136	171,50	
	65	Rp 2,5"	R 2,5"	121	SW 110			543137	375,80	
	80	Rp 3"	R 3"	125	SW 120			543138	494,60	
	100	Rp 4"	R 4"	155	SW 155			543139	831,10	

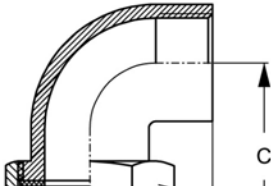
Winkelverschraub. mit Dichtung, Rp Angle union with washer, Rp 	DN	A	B	C	D			AISI316C-PTFE		
	15	Rp 1/2"	26	49,1	SW 32			543231	41,20	
	20	Rp 3/4"	30	55,1	SW 36			543232	30,60	
	25	Rp 1"	35	63,1	SW 46			543233	68,50	
	32	Rp 1,25"	42	73,6	SW 55			543234	93,10	
	40	Rp 1,5"	45	79,6	SW 60			543235	125,50	
50	Rp 2"	53	89,7	SW 75			543236	171,40		