

## Klemmverbindungen DIN 11864-3 + DIN 11853-3

Clamp pipe connections DIN 11864-3 + DIN 11853-3

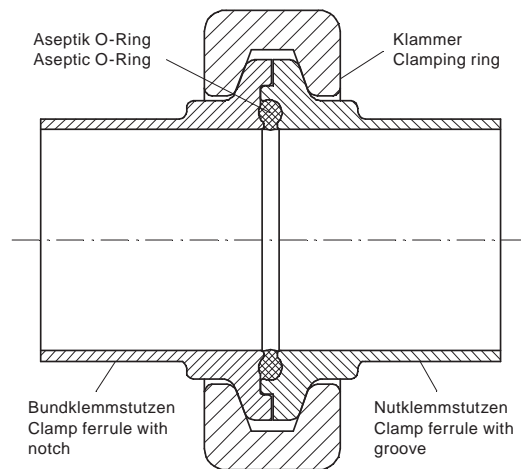

### Einsatzgebiete

Die Aseptik- und die Hygiene-Klemmverbindungen sind kompatibel und unterscheiden sich nur in der axialen Länge. Sie werden bei verfahrenstechnischen Anlagen für flüssige Medien mit hohen Reinheitsanforderungen eingesetzt. Bevorzugte Anwendungsbereiche sind die Biotechnik, Kosmetik-, Pharma-, Chemie-, Lebensmittel- und Getränkeindustrie.

### Montage

Bei der Montage wird der O-Ring in den Nutklemmstutzen eingesetzt, wodurch der O-Ring selbsttätig gehalten ist. Dann wird der Bundklemmstutzen so dagegengesetzt, dass beide Stutzen ineinander greifen. Die Stutzen und der O-Ring sind damit koaxial zwangszentriert. Anschließend wird die Klammer um die Flansche gelegt und geschlossen (wahlweise mit Sicherheitsverschluss), bis die Stirnflächen der Flansche aneinander stoßen. Dabei wird der O-Ring so verformt, dass ein glatter, tottraumfreier Durchgang und eine dichte Verbindung gegeben sind.

### Merkmale

- Größen: DIN-DN10-300, ASME 0,5"- 4", ISO-DN8-200  
DIN-DN125-300, ISO-DN100-200 in Anlehnung der oben genannten Normen
- Stutzen: AISI316L/1.4404, AISI316L/1.4435 (Ferrit < 0,5 %)
- Oberflächen: Ra innen < 0,8 µm, Ra außen < 1,6 µm (H3),  
Oberflächen H4 und H5 auf Anfrage
- O-Ringe: EPDM, VMQ, FKM, EPDM + FKM USP Class VI,  
PTFE-FKM nahtlos ummantelt; FDA konform
- Klammern: AISI304, AISI316L auf Anfrage, TÜV Bauteilprüfung
- Betriebsdruck: Rohr außen Ø 12,7 bis Ø 41 mm max. 25 bar  
Rohr außen Ø 42,4 bis Ø 70 mm max. 16 bar  
Rohr außen Ø 76,1 bis Ø 219,1 mm max. 10 bar  
Rohr außen Ø 254 bis Ø 304 mm max. 6 bar  
Bei Verwendung geeigneter Klammer und Dichtung

### Application

The aseptic and the hygienic clamp pipe connections are compatible and differ only in the axial length. They are used with process facilities for liquid media with high purity requirements. Preferential fields of application are bio-engineering, cosmetics, pharmaceutical, chemical, food, and beverage industry.

### Assembly

During the assembly the O-Ring is positioned in the clamp ferrule with groove whereby the O-Ring is automatically held. Then the clamp ferrule with notch is put against so that both ferrules interlock. By this the ferrules and the O-Ring are coaxially centred. Then the clamping ring is applied to the flanges and closed (alternatively with safety catch) until the fronts of the flanges get together. Thereby, the O-Ring is deformed in such way that an even and free of dead space thoroughfare and a tight connection is attained.

### Features

- Sizes: DIN-DN10-300, ASME 0,5"- 4", ISO-DN8-200  
DIN-DN125-300, ISO-DN100-200 according to the above mentioned standards
- Ferrules: AISI316L/1.4404, AISI316L/1.4435 (Ferrit < 0,5 %)
- Surfaces: Ra inside < 0,8 µm, Ra outside < 1,6 µm (H3),  
surfaces H4 and H5 on inquiry
- O-Rings: EPDM, VMQ, FKM, EPDM + FKM USP Class VI,  
PTFE-FKM seamless enveloped; FDA conform
- Clamping rings: AISI304, AISI316L on inquiry, TÜV Type-test
- Pressure: Tube outer Ø 12,7 up to Ø 41 mm max. 25 bar  
Tube outer Ø 42,4 up to Ø 70 mm max. 16 bar  
Tube outer Ø 76,1 up to Ø 219,1 mm max. 10 bar  
Tube outer Ø 254 up to Ø 304 mm max. 6 bar  
If suitable clamping ring and gasket are used

Artikel	Seite
Klammern .....	176
O-Ringe .....	176
Blind-Nutmummstutzen .....	180
Blind-Bundklemmstutzen .....	181
Schaugläser .....	182
Nutmummstutzen (NS) .....	183
Bundklemmstutzen (BS) .....	185
Zwischenstücke .....	187

Articles	Page
Clamping rings .....	176
O-Rings .....	176
Clamp blind flanges with groove .....	180
Clamp blind flanges with notch .....	181
Sight glasses .....	182
Clamp ferrules with groove (NS) .....	183
Clamp ferrules with notch (BS) .....	185
Intermediate pieces .....	187

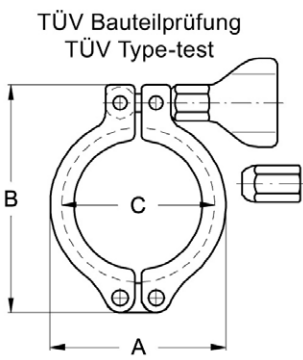
Klemmverbindungen DIN 11864-3 + DIN 11853-3							Art.No.	EUR	Art.No.	EUR
<b>Klammer FL-Stabil</b> <b>Clamping ring FL-Stabil</b>  TÜV Bauteilprüfung TÜV Type-test  	DN	A	B	C	Ø Flansch flange		AISI304 Flügelmutter Wing nut		AISI304 Sechskantmutter Hexagonalnut	
	10-20	44	62	37	34		210760	<b>28,20</b>	211160	<b>28,20</b>
	25-40	64,5	87	54,5	50,5		210716	<b>32,20</b>	211116	<b>32,20</b>
	50	78	100,5	68	64		210705	<b>35,80</b>	211105	<b>35,80</b>
	2,5"	91,5	115	81,5	77,5		210706	<b>38,70</b>	211106	<b>38,70</b>
	65	105	129,5	95	91		210707	<b>43,30</b>	211107	<b>43,30</b>
	80	120	145,5	110	106		210738	<b>45,90</b>	211138	<b>45,90</b>
	100	133	159,5	123	119		210708	<b>49,10</b>	211108	<b>49,10</b>
	115	144	171	134	130		210709	<b>69,60</b>	211109	<b>69,60</b>
	125	175	215	159	155		210710	<b>138,10</b>	211110	<b>138,10</b>
	150	203	243	187	183		210711	<b>153,70</b>	211111	<b>153,70</b>
	200	253,5	295,5	237,5	233,5		210712	<b>178,60</b>	211112	<b>178,60</b>
	250	291	344,5	272	268		210746	<b>248,50</b>	211146	<b>248,50</b>
	300	342	399,5	323	319		210748	<b>295,60</b>	211148	<b>295,60</b>
	Andere Klammern siehe Kapitel D Other clamping rings see chapter D									

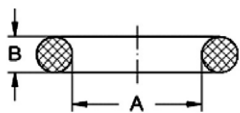
O-Ring DIN O-Ring DIN	DN	A	B				EPDM		EPDM USP Class VI	
	10	12	3,5				471330	<b>3,60</b>	490730	Anfrage
	15	18	3,5				471331	<b>3,60</b>	490731	Anfrage
	20	22	3,5				471332	<b>3,80</b>	490732	Anfrage
	25	28	3,5				471333	<b>4,10</b>	490733	Anfrage
	32	34	5				471334	<b>4,40</b>	490734	Anfrage
	40	40	5				471335	<b>4,60</b>	490735	Anfrage
	50	52	5				471336	<b>5,10</b>	490736	Anfrage
	65	68	5				471337	<b>5,70</b>	490737	Anfrage
	80	83	5				471338	<b>6,90</b>	490738	Anfrage
	100	102	5				471339	<b>7,40</b>	490739	Anfrage
	125 *	127	5				471341	<b>12,30</b>		
	150 *	152	5				471342	<b>14,90</b>		
	200 *	202	5				471344	<b>19,50</b>		
	250 *	252	5				471346	Anfrage		
	300 *	302	5				471348	Anfrage		
* Ähnlich DIN 11864-3, * Similar to DIN 11864-3										

DN	A	B					VMQ	
10	12	3,5					475430	<b>3,60</b>
15	18	3,5					475431	<b>3,60</b>
20	22	3,5					475432	<b>3,80</b>
25	28	3,5					475433	<b>4,10</b>
32	34	5					475434	<b>4,40</b>
40	40	5					475435	<b>4,60</b>
50	52	5					475436	<b>5,10</b>
65	68	5					475437	<b>5,70</b>
80	83	5					475438	<b>6,90</b>
100	102	5					475439	<b>7,40</b>
125 *	127	5					475441	<b>12,30</b>
150 *	152	5					475442	<b>14,90</b>

Klemmverbindungen DIN 11864-3 + DIN 11853-3							Art.No.	EUR	Art.No.	EUR
O-Ring DIN O-Ring DIN	DN	A	B						VMQ	
	200 *	202	5						475444	19,40
	250 *	252	5						475446	Anfrage
	300 *	302	5						475448	Anfrage
* Ähnlich DIN 11864-3, * Similar to DIN 11864-3										

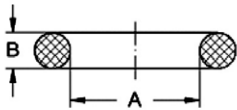

DN	A	B				FKM		FKM USP Class VI		
10	12	3,5				471430	5,80	491030	Anfrage	
15	18	3,5				471431	5,80	491031	Anfrage	
20	22	3,5				471432	6,60	491032	Anfrage	
25	28	3,5				471433	8,20	491033	Anfrage	
32	34	5				471434	12,30	491034	Anfrage	
40	40	5				471435	13,40	491035	Anfrage	
50	52	5				471436	14,90	491036	Anfrage	
65	68	5				471437	16,70	491037	Anfrage	
80	83	5				471438	19,40	491038	Anfrage	
100	102	5				471439	24,30	491039	Anfrage	
125 *	127	5				471441	30,40			
150 *	152	5				471442	37,10			
200 *	202	5				471444	41,10			
250 *	252	5				471446	Anfrage			
300 *	302	5				471448	Anfrage			
* Ähnlich DIN 11864-3, * Similar to DIN 11864-3										

O-Ring DIN, nahtlos ummantelt  
O-Ring DIN, seamless enveloped

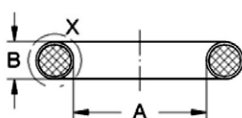

Detail X

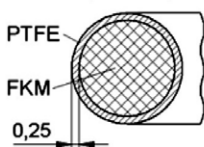

DN	A	B						PTFE-FKM		
10	12	3,5						485530	Anfrage	
15	18	3,5						485531	Anfrage	
20	22	3,5						485532	Anfrage	
25	28	3,5						485533	Anfrage	
32	34	5						485534	Anfrage	
40	40	5						485535	Anfrage	
50	52	5						485536	Anfrage	
65	68	5						485537	Anfrage	
80	83	5						485538	Anfrage	
100	102	5						485539	Anfrage	
125 *	127	5						485541	Anfrage	
150 *	152	5						485542	Anfrage	
200 *	202	5						485544	Anfrage	
250 *	252	5						485546	Anfrage	
300 *	302	5						485548	Anfrage	
* Ähnlich DIN 11864-3, * Similar to DIN 11864-3										

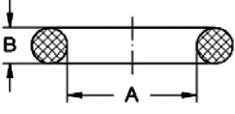
Klemmverbindungen DIN 11864-3 + DIN 11853-3							Art.No.	EUR	Art.No.	EUR
O-Ring ASME O-Ring ASME  	DN	A	B				EPDM		EPDM USP VI	
	0,5"	12	3,5				471330	3,60	490730	Anfrage
	0,75"	18	3,5				471331	3,60	490731	Anfrage
	1"	24	3,5				477103	3,90	490803	Anfrage
	1,5"	37	5				477104	4,70	490804	Anfrage
	2"	50	5				477105	4,90	490805	Anfrage
	2,5"	62	5				477106	5,60	490806	Anfrage
	3"	75	5				477107	6,50	490807	Anfrage
	4"	100	5				477108	7,30	490808	Anfrage

DN	A	B					VMQ	
0,5"	12	3,5					475430	3,60
0,75"	18	3,5					475431	3,60
1"	24	3,5					477203	3,90
1,5"	37	5					477204	4,70
2"	50	5					477205	4,90
2,5"	62	5					477206	5,60
3"	75	5					477207	6,50
4"	100	5					477208	7,30

DN	A	B					FKM		FKM USP VI	
0,5"	12	3,5					471430	5,80	491030	Anfrage
0,75"	18	3,5					471431	5,80	491031	Anfrage
1"	24	3,5					477303	7,20	491103	Anfrage
1,5"	37	5					477304	13,40	491104	Anfrage
2"	50	5					477305	14,70	491105	Anfrage
2,5"	62	5					477306	16,30	491106	Anfrage
3"	75	5					477307	17,90	491107	Anfrage
4"	100	5					477308	24,10	491108	Anfrage

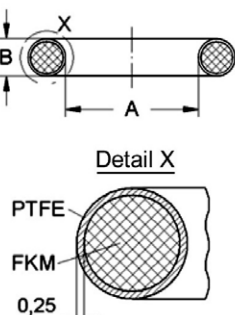
O-Ring ASME, nahtlos ummantelt O-Ring ASME, seamless enveloped  	DN	A	B				PTFE-FKM				
	0,5"	12	3,5							485530	Anfrage
	0,75"	18	3,5							485531	Anfrage
	1"	24	3,5							485603	Anfrage
	1,5"	37	5							485604	Anfrage
	2"	50	5							485605	Anfrage
	2,5"	62	5							485606	Anfrage
	3"	75	5							485607	Anfrage
	4"	100	5							485608	Anfrage

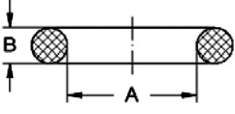
Klemmverbindungen DIN 11864-3 + DIN 11853-3							Art.No.	EUR	Art.No.	EUR
O-Ring ISO O-Ring ISO  	DN	A	B				EPDM		EPDM USP Class VI	
	13,5	12	3,5				471330	3,60	490730	Anfrage
	17,2	16	3,5				471530	3,60	490930	Anfrage
	21,3	20	3,5				471531	3,90	490931	Anfrage
	26,9	26	3,5				471532	4,10	490932	Anfrage
	33,7	32	5				471533	4,40	490933	Anfrage
	42,4	40,5	5				471534	4,60	490934	Anfrage
	48,3	46,5	5				471535	5,10	490935	Anfrage
	60,3	58,5	5				471536	5,40	490936	Anfrage
	76,1	73,5	5				471537	5,90	490937	Anfrage
	88,9	86,5	5				471538	7,20	490938	Anfrage
	114,3 *	111	5				471539	8,40	490939	Anfrage
	139,7 *	136,5	5				471541	13,80		
	168,3 *	165	5				471542	16,90		
	219,1 *	216	5				471544	21,80		
* Ähnlich DIN 11864-3, * Similar to DIN 11864-3										
DN	A	B					VMQ			
13,5	12	3,5						475430	3,60	
17,2	12	3,5						475530	3,60	
21,3	20	3,5						475531	3,90	
26,9	26	3,5						475532	4,10	
33,7	32	5						475533	4,40	
42,4	40,5	5						475534	4,60	
48,3	46,5	5						475535	5,10	
60,3	58,5	5						475536	5,40	
76,1	73,5	5						475537	5,90	
88,9	86,5	5						475538	7,20	
114,3 *	111	5						475539	8,40	
139,7 *	136,5	5						475541	13,80	
168,3 *	165	5						475542	16,90	
219,1 *	216	5						475544	21,80	
* Ähnlich DIN 11864-3, * Similar to DIN 11864-3										
DN	A	B					FKM		FKM USP Class VI	
13,5	12	3,5					471430	5,80	491030	Anfrage
17,2	16	3,5					475630	5,80	491230	Anfrage
21,3	20	3,5					475631	6,60	491231	Anfrage
26,9	26	3,5					475632	8,30	491232	Anfrage
33,7	32	5					475633	12,30	491233	Anfrage
42,4	40,5	5					475634	13,40	491234	Anfrage
48,3	46,5	5					475635	14,90	491235	Anfrage
60,3	58,5	5					475636	15,80	491236	Anfrage
76,1	73,5	5					475637	17,50	491237	Anfrage
88,9	86,5	5					475638	19,90	491238	Anfrage
114,3 *	111	5					475639	24,10	491239	Anfrage
139,7 *	136,5	5					475641	27,60		
168,3 *	165	5					475642	32,30		
219,1 *	216	5					475644	42,80		
* Ähnlich DIN 11864-3, * Similar to DIN 11864-3										

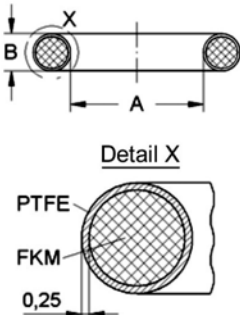
Klemmverbindungen DIN 11864-3 + DIN 11853-3							Art.No.	EUR	Art.No.	EUR
<b>O-Ring ISO, nahtlos ummantelt</b> <b>O-Ring ISO, seamless enveloped</b> 	DN	A	B					PTFE-FKM		
	13,5	12	3,5					485530	Anfrage	
	17,2	16	3,5					485730	Anfrage	
	21,3	20	3,5					485731	Anfrage	
	26,9	26	3,5					485732	Anfrage	
	33,7	32	5					485733	Anfrage	
	42,4	40,5	5					485734	Anfrage	
	48,3	46,5	5					485735	Anfrage	
	60,3	58,5	5					485736	Anfrage	
	76,1	73,5	5					485737	Anfrage	
	88,9	86,5	5					485738	Anfrage	
	114,3 *	111	5					485739	Anfrage	
	139,7 *	136,5	5					485741	Anfrage	
	168,3 *	165	5					485742	Anfrage	
	219,1 *	216	5					485744	Anfrage	
* Ähnlich DIN 11864-3, * Similar to DIN 11864-3										

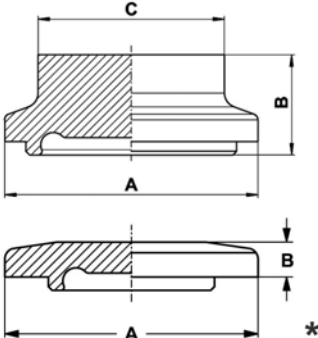
<b>Blind-Nutklemmstutzen DIN</b> <b>Clamp blind flange with groove DIN</b> 	DN	A	B	C			AISI316L-1.4404		AISI316L-1.4435	
	10	34	13	25			476130	Anfrage	486730	Anfrage
	15	34	13	25			476131	Anfrage	486731	Anfrage
	20	50,5	13	42			476132	Anfrage	486732	Anfrage
	25	50,5	13	42			476133	Anfrage	486733	Anfrage
	32	50,5	13	42			476134	Anfrage	486734	Anfrage
	40	64	13	54			476135	Anfrage	486735	Anfrage
	50	77,5	15	62			476136	Anfrage	486736	Anfrage
	65	91	15	78			476137	Anfrage	486737	Anfrage
	80	106	15	93			476138	Anfrage	486738	Anfrage
	100	130	15	115					486739	Anfrage
	125 *	155	14	-			476141	Anfrage	486741	Anfrage
	150 *	183	14	-			476142	Anfrage	486742	Anfrage
	200 *	233,5	14	-			476144	Anfrage	486744	Anfrage
	250 *	268	14	-			476146	Anfrage	486746	Anfrage
300 *	319	14	-			476148	Anfrage	486748	Anfrage	
* Ähnlich DIN 11853-3, * Similar to DIN 11853-3										

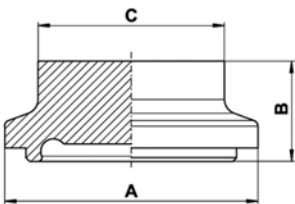
<b>Blind-Nutklemmstutzen ASME</b> <b>Clamp blind fl. w. groove ASME</b> 	DN	A	B	C			AISI316L-1.4435				
	0,5"	34	13	25					486801	Anfrage	
	0,75"	34	13	25					486802	Anfrage	
	1"	50,5	13	42					486803	Anfrage	
	1,5"	64	13	54					486804	Anfrage	
	2"	77,5	15	62					486805	Anfrage	
	2,5"	91	15	78					486806	Anfrage	
	3"	106	15	93					486807	Anfrage	
	4"	130	15	115					486808	Anfrage	

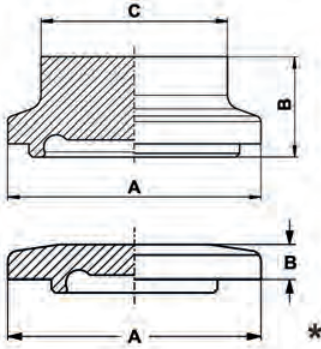
Klemmverbindungen DIN 11864-3 + DIN 11853-3						Art.No.	EUR	Art.No.	EUR
<b>Blind-Nutklemmstutzen ISO</b> Clamp blind flange with groove ISO 	DN	A	B	C		AISI316L-1.4404		AISI316L-1.4435	
	13,5	34	13	25		476229	Anfrage	486929	Anfrage
	17,2	34	13	25		476230	Anfrage	486930	Anfrage
	21,3	34	13	25		476231	Anfrage	486931	Anfrage
	26,9	50,5	13	42		476232	Anfrage	486932	Anfrage
	33,7	50,5	13	42		476233	Anfrage	486933	Anfrage
	42,4	64	13	54		476234	Anfrage	486934	Anfrage
	48,3	64	13	54		476235	Anfrage	486935	Anfrage
	60,3	91	15	78		476236	Anfrage	486936	Anfrage
	76,1	106	15	93		476237	Anfrage	486937	Anfrage
	88,9	119	15	104		476238	Anfrage	486938	Anfrage
	114,3 *	130	15	-		476239	Anfrage	486939	Anfrage
	139,7 *	155	14	-		476241	Anfrage	486941	Anfrage
	168,3 *	183	14	-		476242	Anfrage	486942	Anfrage
219,1 *	233,5	14	-		476244	Anfrage	486944	Anfrage	
* Ähnlich DIN 11853-3, * Similar to DIN 11853-3									

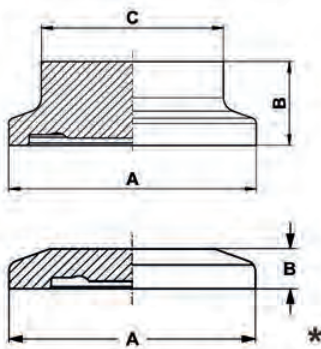
<b>Blind-Bundklemmstutzen DIN</b> Clamp blind flange with notch DIN 	DN	A	B	C		AISI316L-1.4404		AISI316L-1.4435	
	10	34	11,5	25		476330	Anfrage	487030	Anfrage
	15	34	11,5	25		476331	Anfrage	487031	Anfrage
	20	50,5	11,5	42		476332	Anfrage	487032	Anfrage
	25	50,5	11,5	42		476333	Anfrage	487033	Anfrage
	32	50,5	11,5	42		476334	Anfrage	487034	Anfrage
	40	64	11,5	54		476335	Anfrage	487035	Anfrage
	50	77,5	13,5	62		476336	Anfrage	487036	Anfrage
	65	91	13,5	78		476337	Anfrage	487037	Anfrage
	80	106	13,5	93		476338	Anfrage	487038	Anfrage
	100	130	13,5	115				487039	Anfrage
	125 *	155	12,5	-		476341	Anfrage	487041	Anfrage
	150 *	183	12,5	-		476342	Anfrage	487042	Anfrage
	200 *	233,5	12,5	-		476344	Anfrage	487044	Anfrage
	250 *	268	12,5	-		476346	Anfrage	487046	Anfrage
	300 *	319	12,5	-		476348	Anfrage	487048	Anfrage
* Ähnlich DIN 11853-3, * Similar to DIN 11853-3									

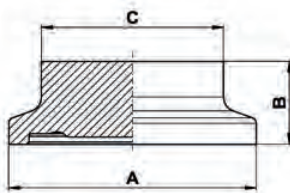
<b>Blind-Bundklemmstutzen ASME</b> Clamp blind fl. w. notch ASME 	DN	A	B	C		AISI316L-1.4435				
	0,5"	34	11,5	25					487101	Anfrage
	0,75"	34	11,5	25					487102	Anfrage
	1"	50,5	11,5	42					487103	Anfrage
	1,5"	64	11,5	54					487104	Anfrage
	2"	77,5	13,5	62					487105	Anfrage
	2,5"	91	13,5	78					487106	Anfrage
	3"	106	13,5	93					487107	Anfrage
	4"	130	13,5	115					487108	Anfrage

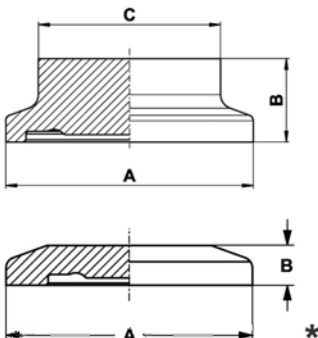
Klemmverbindungen DIN 11864-3 + DIN 11853-3							Art.No.	EUR	Art.No.	EUR
<b>Blind-Bundklemmstutzen ISO</b> Clamp blind flange with notch ISO 	DN	A	B	C			AISI316L-1.4404		AISI316L-1.4435	
	13,5	34	11,5	25			476429	Anfrage	487229	Anfrage
	17,2	34	11,5	25			476430	Anfrage	487230	Anfrage
	21,3	34	11,5	25			476431	Anfrage	487231	Anfrage
	26,9	50,5	11,5	42			476432	Anfrage	487232	Anfrage
	33,7	50,5	11,5	42			476433	Anfrage	487233	Anfrage
	42,2	64	11,5	54			476434	Anfrage	487234	Anfrage
	48,3	64	11,5	54			476435	Anfrage	487235	Anfrage
	60,3	91	13,5	78			476436	Anfrage	487236	Anfrage
	76,1	106	13,5	93			476437	Anfrage	487237	Anfrage
	88,9	119	13,5	104			476438	Anfrage	487238	Anfrage
	114,3 *	130	13,5	-			476439	Anfrage	487239	Anfrage
	139,7 *	155	12,5	-			476441	Anfrage	487241	Anfrage
	168,3 *	183	12,5	-			476442	Anfrage	487242	Anfrage
219,1 *	233,5	12,5	-			476444	Anfrage	487244	Anfrage	
* Ähnlich DIN 11853-3, * Similar to DIN 11853-3										

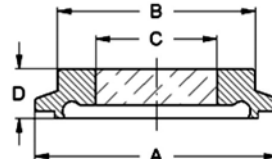
<b>Nutklemmschauglas DIN</b> Clamp sight glass with groove DIN 	DN	A	B	C	D	bar	1.4462-Borosilikat		2.4602-Borosilikat	
	20	50,5	42	20	12	16	486432	236,50	491532	Anfrage
	25	50,5	42	22	12	16	486433	236,50	491533	Anfrage
	32	50,5	42	22	14	16	486434	236,50	491534	Anfrage
	40	64	54	30	14	16	486435	247,90	491535	Anfrage
	50	77,5	62	35	14	16	486436	294,40	491536	Anfrage
	65	91	78	40	16	16	486437	333,10	491537	Anfrage
	80	106	93	50	16	10	486438	354,50	491538	Anfrage
	100	130	115	60	20	10	486439	490,20	491539	Anfrage
	125	155	130	65	22	10	486441	643,40	491541	Anfrage
	150	183	160	80	25	10	486442	853,80	491542	Anfrage
	-30 °C bis 280 °C -30 °C up to 280 °C									

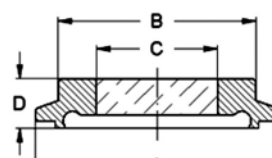
<b>Nutklemmschauglas ASME</b> Clamp sight glass with groove ASM 	DN	A	B	C	D	bar	1.4462-Borosilikat		2.4602-Borosilikat	
	1"	50,5	42	22	12	16	486503	236,50	491603	Anfrage
	1,5"	64	54	30	14	16	486504	247,90	491604	Anfrage
	2"	77,5	62	35	14	16	486505	294,40	491605	Anfrage
	2,5"	91	76	40	16	16	486506	333,10	491606	Anfrage
	3"	106	93	50	16	10	486507	354,50	491607	Anfrage
	4"	130	115	60	20	10	486508	490,20	491608	Anfrage
-30 °C bis 280 °C -30 °C up to 280 °C										

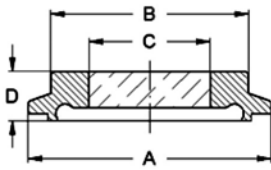

Klemmverbindungen DIN 11864-3 + DIN 11853-3							Art.No.	EUR	Art.No.	EUR
<b>Nutklemmschauglas ISO</b> Clamp sight glass with groove ISO 	DN	A	B	C	D	bar	1.4462-Borosilikat		2.4602-Borosilikat	
	26,9	50,5	42	22	12	16	486632	<b>236,50</b>	491732	Anfrage
	33,7	50,5	42	22	14	16	486633	<b>236,50</b>	491733	Anfrage
	42,4	64	54	30	14	16	486634	<b>247,90</b>	491734	Anfrage
	48,3	64	54	30	14	16	486635	<b>247,90</b>	491735	Anfrage
	60,3	91	78	40	16	10	486636	<b>333,10</b>	491736	Anfrage
	76,1	106	93	50	16	10	486637	<b>354,50</b>	491737	Anfrage
	88,9	119	104	55	18	10	486638	<b>393,40</b>	491738	Anfrage
-30 °C bis 280 °C -30 °C up to 280 °C										

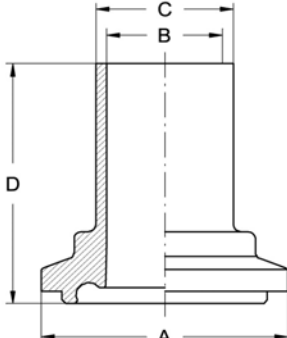
<b>Nutklemmstutzen DIN DIN11864-3</b> Clamp ferrule with groove DIN, DIN 11864-3 	DN	A	B	C	D		AISI316L-1.4404		AISI316L-1.4435	
	10	34	10	13	39,5		487330	<b>32,80</b>	487430	Anfrage
	15	34	16	19	39,5		487331	<b>33,70</b>	487431	Anfrage
	20	50,5	20	23	39,5		487332	<b>38,40</b>	487432	Anfrage
	25	50,5	26	29	40		487333	<b>39,80</b>	487433	Anfrage
	32	50,5	32	35	45,5		487334	<b>43,70</b>	487434	Anfrage
	40	64	38	41	45,5		487335	<b>45,60</b>	487435	Anfrage
	50	77,5	50	53	46		487336	<b>57,10</b>	487436	Anfrage
	65	91	66	70	58		487337	<b>80,90</b>	487437	Anfrage
	80	106	81	85	60		487338	<b>85,30</b>	487438	Anfrage
	100	130	100	104	61,5		487339	<b>96,20</b>	487439	Anfrage

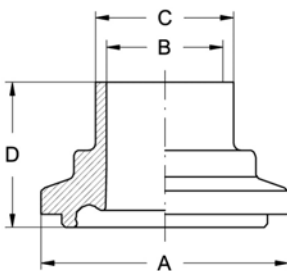
<b>Nutklemmstutzen DIN DIN11853-3</b> Clamp ferrule with groove DIN, DIN 11853-3 	DN	A	B	C	D		AISI316L-1.4435		AISI316L-1.4404	
	10	34	10	13	23,5				475730	Anfrage
	15	34	16	19	23,5				475731	Anfrage
	20	50,5	20	23	23,5				475732	Anfrage
	25	50,5	26	29	22				475733	Anfrage
	32	50,5	32	35	25,5				475734	Anfrage
	40	64	38	41	25,5				475735	Anfrage
	50	77,5	50	53	26				475736	Anfrage
	65	91	66	70	28				475737	Anfrage
	80	106	81	85	30				475738	Anfrage
	100	130	100	104	31,5				475739	Anfrage
	125 *	155	125	129	37		491841	<b>Anfrage</b>		
	150 *	183	150	154	37		491842	<b>Anfrage</b>		
	200 *	233,5	200	204	37		491844	<b>Anfrage</b>		
	250 *	268	250	254	37		491846	<b>Anfrage</b>		
300 *	319	300	304	37		491848	<b>Anfrage</b>			
* Ähnlich DIN 11853-3, * Similar to DIN 11853-3										

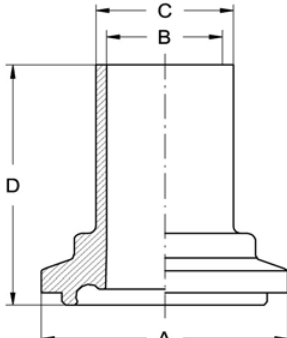
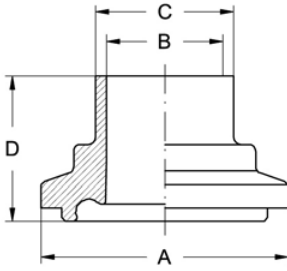
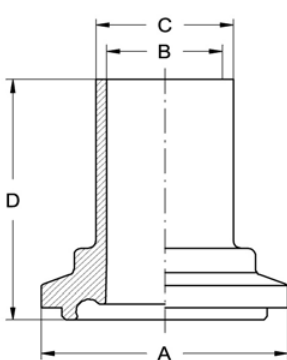
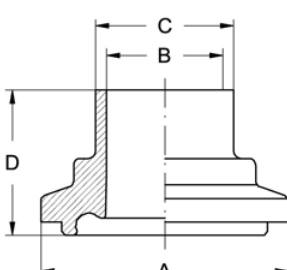
Klemmverbindungen DIN 11864-3 + DIN 11853-3							Art.No.	EUR	Art.No.	EUR
<b>Nutklemmstutzen ASME DIN 11864-3</b> Clamp ferrule w. groove ASME DIN 11864-3 	DN	A	B	C	D		AISI316L-1.4404		AISI316L-1.4435	
	0,5"	34	9,4	12,7	39,5		490301	Anfrage	487501	Anfrage
	0,75"	34	15,75	19,05	39,5		490302	Anfrage	487502	Anfrage
	1"	50,5	22,1	25,4	40		490303	38,40	487503	Anfrage
	1,5"	64	34,8	38,1	45,5		490304	45,70	487504	Anfrage
	2"	77,5	47,5	50,8	46		490305	57,10	487505	Anfrage
	2,5"	91	60,2	63,5	59		490306	86,50	487506	Anfrage
	3"	106	72,9	76,2	60		490307	109,50	487507	Anfrage
	4"	130	97,4	101,6	61		490308	123,70	487508	Anfrage
<b>Nutklemmstutzen ASME DIN 11853-3</b> Clamp ferrule w. groove ASME DIN 11853-3 	DN	A	B	C	D		AISI316L-1.4404			
	0,5"	34	9,4	12,7	23,5				491301	Anfrage
	0,75"	34	15,75	19,05	23,5				491302	Anfrage
	1"	50,5	22,1	25,4	22				491303	Anfrage
	1,5"	64	34,8	38,1	25,5				491304	Anfrage
	2"	77,5	47,5	50,8	26				491305	Anfrage
	2,5"	91	60,2	63,5	29				491306	Anfrage
	3"	106	72,9	76,2	30				491307	Anfrage
	4"	130	97,4	101,6	31				491308	Anfrage
<b>Nutklemmstutzen ISO DIN 11864-3</b> Clamp ferrule with groove ISO, DIN 11864-3 	DN	A	B	C	D		AISI316L-1.4404		AISI316L-1.4435	
	13,5	34	10,3	13,5	39,5		490429	25,90	487629	Anfrage
	17,2	34	14	17,2	39,5		490430	25,90	487630	Anfrage
	21,3	34	18,1	21,3	40,5		490431	25,90	487631	Anfrage
	26,9	50,5	23,7	26,9	40,5		490432	38,40	487632	Anfrage
	33,7	50,5	29,7	33,7	45,5		490433	40,50	487633	Anfrage
	42,4	64	38,4	42,4	45,5		490434	45,70	487634	Anfrage
	48,3	64	44,3	48,3	46,5		490435	49,20	487635	Anfrage
	60,3	91	56,3	60,3	58,5		490436	66,70	487636	Anfrage
	76,1	106	72,1	76,1	60		490437	91,10	487637	Anfrage
	88,9	119	84,3	88,9	62,5		490438	105,50	487638	Anfrage
114,3	130	109,7	114,3	66,5		490439	125,60	487639	Anfrage	
<b>Nutklemmstutzen ISO DIN 11853-3</b> Clamp ferrule with groove ISO DIN 11853-3 	DN	A	B	C	D		AISI316L-1.4404			
	13,5	34	10,3	13,5	23,5				475829	Anfrage
	17,2	34	14	17,2	23,5				475830	Anfrage
	21,3	34	18,1	21,3	24,5				475831	Anfrage
	26,9	50,5	23,7	26,9	20,5				475832	Anfrage
	33,7	50,5	29,7	33,7	25,5				475833	Anfrage
	42,4	64	38,4	42,4	25,5				475834	Anfrage
	48,3	64	44,3	48,3	26,5				475835	Anfrage
	60,3	91	56,3	60,3	28,5				475836	Anfrage
	76,1	106	72,1	76,1	30				475837	Anfrage
	88,9	119	84,3	88,9	32,5				475838	Anfrage
114,3	130	109,7	114,3	31,5				475839	Anfrage	
139,7 *	155	134,5	139,7	37				475841	Anfrage	

Klemmverbindungen DIN 11864-3 + DIN 11853-3						Art.No.	EUR	Art.No.	EUR
<b>Nutklemmstutzen ISO DIN11853-3</b> Clamp ferrule with groove ISO DIN 11853-3	<b>DN</b>	<b>A</b>	<b>B</b>	<b>C</b>	<b>D</b>			AISI316L-1.4404	
	<b>168,3 *</b>	183	163,1	168,3	37			475842	Anfrage
	<b>219,1 *</b>	233,5	213,9	219,1	37			475844	Anfrage
* Ähnlich DIN 11853-3, * Similar to DIN 11853-3									

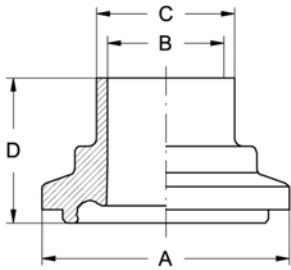

<b>Bundklemmstutzen DIN DIN11864-3</b> Clamp ferrule w. notch DIN DIN11864-3	<b>DN</b>	<b>A</b>	<b>B</b>	<b>C</b>	<b>D</b>		AISI316L-1.4404		AISI316L-1.4435	
	<b>10</b>	34	10	13	38		487730	<b>30,40</b>	487830	Anfrage
	<b>15</b>	34	16	19	38		487731	<b>31,80</b>	487831	Anfrage
	<b>20</b>	50,5	20	23	38		487732	<b>34,90</b>	487832	Anfrage
	<b>25</b>	50,5	26	29	38,5		487733	<b>36,40</b>	487833	Anfrage
	<b>32</b>	50,5	32	35	44		487734	<b>42,40</b>	487834	Anfrage
	<b>40</b>	64	38	41	44		487735	<b>45,30</b>	487835	Anfrage
	<b>50</b>	77,5	50	53	44,5		487736	<b>54,60</b>	487836	Anfrage
	<b>65</b>	91	66	70	56,5		487737	<b>78,50</b>	487837	Anfrage
	<b>80</b>	106	81	85	58,5		487738	<b>84,50</b>	487838	Anfrage
<b>100</b>	130	100	104	60		487739	<b>94,10</b>	487839	Anfrage	

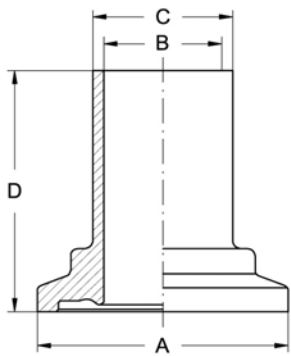

<b>Bundklemmstutzen DIN DIN11853-3</b> Clamp ferrule w. notch DIN DIN11853-3	<b>DN</b>	<b>A</b>	<b>B</b>	<b>C</b>	<b>D</b>		AISI316L-1.4435		AISI316L-1.4404	
	<b>10</b>	34	10	13	22				475930	Anfrage
	<b>15</b>	34	16	19	22				475931	Anfrage
	<b>20</b>	50,5	20	23	22				475932	Anfrage
	<b>25</b>	50,5	26	29	20,5				475933	Anfrage
	<b>32</b>	50,5	32	35	24				475934	Anfrage
	<b>40</b>	64	38	41	24				475935	Anfrage
	<b>50</b>	77,5	50	53	24,5				475936	Anfrage
	<b>65</b>	91	66	70	26,5				475937	Anfrage
	<b>80</b>	106	81	85	28,5				475938	Anfrage
	<b>100</b>	130	100	104	30				475939	Anfrage
	<b>125 *</b>	155	125	129	37		491941	<b>Anfrage</b>		
	<b>150 *</b>	183	150	154	37		491942	<b>Anfrage</b>		
	<b>200 *</b>	233,5	200	204	37		491944	<b>Anfrage</b>		
<b>250 *</b>	268	250	254	37		491946	<b>Anfrage</b>			
<b>300 *</b>	319	300	304	37		491948	<b>Anfrage</b>			
* Ähnlich DIN 11853-3, * Similar to DIN 11853-3										

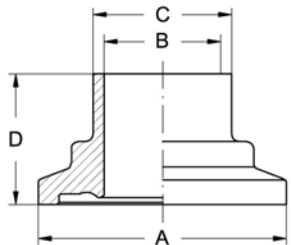

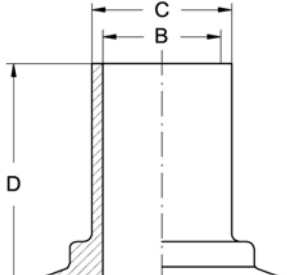
Klemmverbindungen DIN 11864-3 + DIN 11853-3							Art.No.	EUR	Art.No.	EUR
<b>Bundklemmst. ASME DIN11864-3</b> Clamp ferrule w. notch ASME DIN1186 	DN	A	B	C	D		AISI316L-1.4404		AISI316L-1.4435	
	0,5"	34	9,4	12,7	38		490501	Anfrage	487901	Anfrage
	0,75"	34	15,75	19,05	38		490502	Anfrage	487902	Anfrage
	1"	50,5	22,1	25,4	38,5		490503	28,50	487903	Anfrage
	1,5"	64	34,8	38,1	44		490504	33,70	487904	Anfrage
	2"	77,5	47,5	50,8	44,5		490505	43,20	487905	Anfrage
	2,5"	91	60,2	63,5	57,5		490506	66,70	487906	Anfrage
	3"	106	72,9	76,2	58,5		490507	83,40	487907	Anfrage
	4"	130	97,4	101,6	59,5		490508	113,90	487908	Anfrage

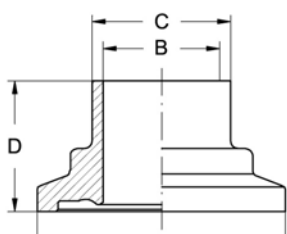
<b>Bundklemmst. ASME DIN11853-3</b> Clamp ferrule w. notch ASME DIN1185 	DN	A	B	C	D		AISI316L-1.4404			
	0,5"	34	9,4	12,7	22				491401	Anfrage
	0,75"	34	15,75	19,05	22				491402	Anfrage
	1"	50,5	22,1	25,4	20,5				491403	Anfrage
	1,5"	64	34,8	38,1	24				491404	Anfrage
	2"	77,5	47,5	50,8	24,5				491405	Anfrage
	2,5"	91	60,2	63,5	27,5				491406	Anfrage
	3"	106	72,9	76,2	28,5				491407	Anfrage
	4"	130	97,4	101,6	29,5				491408	Anfrage

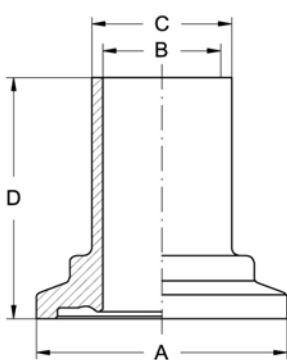
<b>Bundklemmstutzen ISO DIN11864-3</b> Clamp ferrule w. notch ISO DIN11864-3 	DN	A	B	C	D		AISI316L-1.4404		AISI316L-1.4435	
	13,5	34	10,3	13,5	38		490629	23,80	488029	Anfrage
	17,2	34	14	17,2	38		490630	23,80	488030	Anfrage
	21,3	34	18,1	21,3	39		490631	23,80	488031	Anfrage
	26,9	50,5	23,7	26,9	39		490632	27,90	488032	Anfrage
	33,7	50,5	29,7	33,7	44		490633	31,60	488033	Anfrage
	42,4	64	38,4	42,4	44		490634	34,70	488034	Anfrage
	48,3	64	44,3	48,3	45		490635	36,20	488035	Anfrage
	60,3	91	56,3	60,3	57		490636	64,70	488036	Anfrage
	76,1	106	72,1	76,1	58,5		490637	89,80	488037	Anfrage
	88,9	119	84,3	88,9	61		490638	103,80	488038	Anfrage
114,3 *	130	109,7	114,3	65		490639	120,20	488039	Anfrage	
* Ähnlich DIN 11864-3, * Similar to DIN 11864-3										

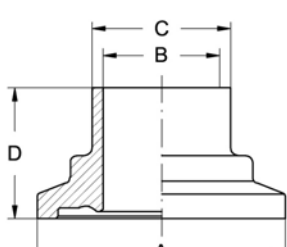
<b>Bundklemmstutzen ISO DIN11853-3</b> Clamp ferrule w. notch ISO DIN11853-3 	DN	A	B	C	D		AISI316L-1.4404			
	13,5	34	10,3	13,5	18				476029	Anfrage
	17,2	34	14	17,2	18				476030	Anfrage
	21,3	34	18,1	21,3	18				476031	Anfrage
	26,9	50,5	23,7	26,9	21,5				476032	Anfrage
	33,7	50,5	29,7	33,7	21,5				476033	Anfrage
	42,4	64	38,4	42,4	21,5				476034	Anfrage
	48,3	64	44,3	48,3	21,5				476035	Anfrage
	60,3	91	56,3	60,3	28				476036	Anfrage
	76,1	106	72,1	76,1	28				476037	Anfrage
	88,9	119	84,3	88,9	28				476038	Anfrage
114,3 *	130	109,1	114,3	28				476039	Anfrage	

Klemmverbindungen DIN 11864-3 + DIN 11853-3							Art.No.	EUR	Art.No.	EUR
<b>Bundklemmstutzen ISO DIN11853-3</b> Clamp ferrule w. notch ISO DIN11853-3	<b>DN</b>	<b>A</b>	<b>B</b>	<b>C</b>	<b>D</b>				AISI316L-1.4404	
	139,7 *	155	134,5	139,7	28				476041	Anfrage
	168,3 *	183	163,1	168,3	28				476042	Anfrage
	219,1 *	233,5	213,9	219,1	28				476044	Anfrage
* Ähnlich DIN 11853-3, * Similar to DIN 11853-3										

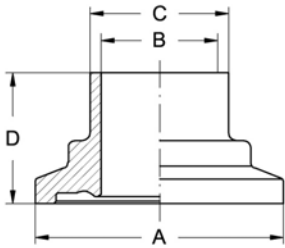

<b>Zwischenstück DIN, NSNS</b> Intermediate piece DIN, NSNS	<b>DN</b>	<b>A</b>	<b>B</b>				AISI316L-1.4404		AISI316L-1.4435	
	10	34	10				476530	Anfrage	488130	Anfrage
	15	34	16				476531	Anfrage	488131	Anfrage
	20	50,5	20				476532	Anfrage	488132	Anfrage
	25	50,5	26				476533	Anfrage	488133	Anfrage
	32	50,5	32				476534	Anfrage	488134	Anfrage
	40	64	38				476535	Anfrage	488135	Anfrage
	50	77,5	50				476536	Anfrage	488136	Anfrage
	65	91	66				476537	Anfrage	488137	Anfrage
	80	106	81				476538	Anfrage	488138	Anfrage
	100	130	100				476539	Anfrage	488139	Anfrage
	125	155	125				476541	Anfrage	488141	Anfrage
	150	183	150				476542	Anfrage	488142	Anfrage
	200	233,5	200				476544	Anfrage	488144	Anfrage
C nach Wunsch C on demand										

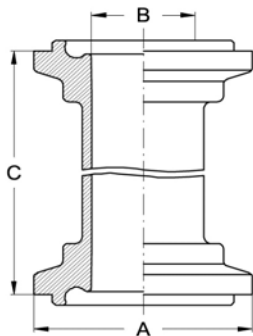

<b>Zwischenstück DIN, NSBS</b> Intermediate piece DIN, NSBS	<b>DN</b>	<b>A</b>	<b>B</b>				AISI316L-1.4404		AISI316L-1.4435	
	10	34	10				476630	Anfrage	488230	Anfrage
	15	34	16				476631	Anfrage	488231	Anfrage
	20	50,5	20				476632	Anfrage	488232	Anfrage
	25	50,5	26				476633	Anfrage	488233	Anfrage
	32	50,5	32				476634	Anfrage	488234	Anfrage
	40	64	38				476635	Anfrage	488235	Anfrage
	50	77,5	50				476636	Anfrage	488236	Anfrage
	65	91	66				476637	Anfrage	488237	Anfrage
	80	106	81				476638	Anfrage	488238	Anfrage
	100	130	100				476639	Anfrage	488239	Anfrage
	125	155	125				476641	Anfrage	488241	Anfrage
	150	183	150				476642	Anfrage	488242	Anfrage
	200	233,5	200				476644	Anfrage	488244	Anfrage
C nach Wunsch C on demand										

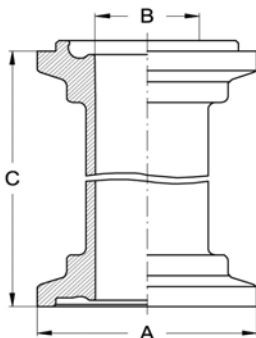

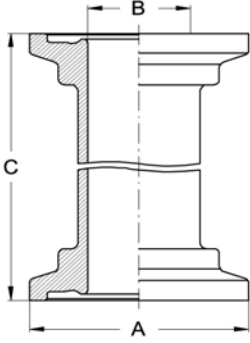
Klemmverbindungen DIN 11864-3 + DIN 11853-3							Art.No.	EUR	Art.No.	EUR
<b>Zwischenstück DIN, BSBS</b> Intermediate piece DIN, BSBS 	DN	A	B				AISI316L-1.4404		AISI316L-1.4435	
	10	34	10				476730	Anfrage	488330	Anfrage
	15	34	16				476731	Anfrage	488331	Anfrage
	20	50,5	20				476732	Anfrage	488332	Anfrage
	25	50,5	26				476733	Anfrage	488333	Anfrage
	32	50,5	32				476734	Anfrage	488334	Anfrage
	40	64	38				476735	Anfrage	488335	Anfrage
	50	77,5	50				476736	Anfrage	488336	Anfrage
	65	91	66				476737	Anfrage	488337	Anfrage
	80	106	81				476738	Anfrage	488338	Anfrage
	100	130	100				476739	Anfrage	488339	Anfrage
	125	155	125				476741	Anfrage	488341	Anfrage
	150	183	150				476742	Anfrage	488342	Anfrage
	200	233,5	200				476744	Anfrage	488344	Anfrage
C nach Wunsch C on demand										

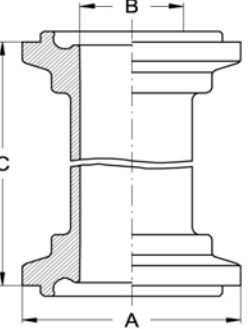
<b>Zwischenstück ASME, NSNS</b> Intermediate piece ASME, NSNS 	DN	A	B				AISI316L-1.4435			
	0,5"	34	9,4						488401	Anfrage
	0,75"	34	15,75						488402	Anfrage
	1"	50,5	22,1						488403	Anfrage
	1,5"	64	34,8						488404	Anfrage
	2"	77,5	47,5						488405	Anfrage
	2,5"	91	60,2						488406	Anfrage
	3"	106	72,9						488407	Anfrage
	4"	130	97,4						488408	Anfrage
	C nach Wunsch C on demand									

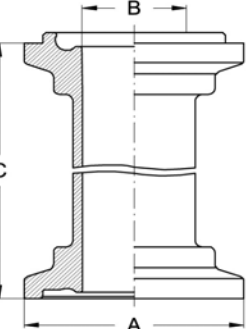
<b>Zwischenstück ASME, NSBS</b> Intermediate piece ASME, NSBS 	DN	A	B				AISI316L-1.4435			
	0,5"	34	9,4						488501	Anfrage
	0,75"	34	15,75						488502	Anfrage
	1"	50,5	22,1						488503	Anfrage
	1,5"	64	34,8						488504	Anfrage
	2"	77,5	47,5						488505	Anfrage
	2,5"	91	60,2						488506	Anfrage
	3"	106	72,9						488507	Anfrage
	4"	130	97,4						488508	Anfrage
	C nach Wunsch C on demand									

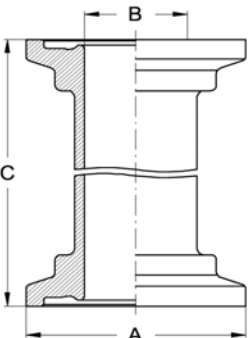
Klemmverbindungen DIN 11864-3 + DIN 11853-3						Art.No.	EUR	Art.No.	EUR
<b>Zwischenstück ASME, BSBS</b> Intermediate piece ASME, BSBS 	DN	A	B			AISI316L-1.4435			
	0,5"	34	9,4					488601	Anfrage
	0,75"	34	15,75					488602	Anfrage
	1"	50,5	22,1					488603	Anfrage
	1,5"	64	34,8					488604	Anfrage
	2"	77,5	47,5					488605	Anfrage
	2,5"	91	60,2					488606	Anfrage
	3"	106	72,9					488607	Anfrage
	4"	130	97,4					488608	Anfrage
<b>C nach Wunsch</b> C on demand									

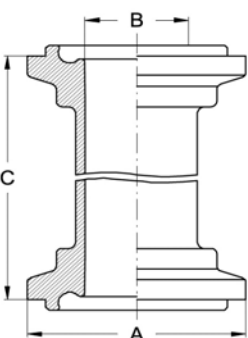
<b>Zwischenstück ISO, NSNS</b> Intermediate piece ISO, NSNS 	DN	A	B			AISI316L-1.4404		AISI316L-1.4435	
	13,5	34	10,3			476829	Anfrage	488729	Anfrage
	17,2	34	14			476830	Anfrage	488730	Anfrage
	21,3	34	18,1			476831	Anfrage	488731	Anfrage
	26,9	50,5	23,7			476832	Anfrage	488732	Anfrage
	33,7	50,5	29,7			476833	Anfrage	488733	Anfrage
	42,4	64	38,4			476834	Anfrage	488734	Anfrage
	48,3	64	44,3			476835	Anfrage	488735	Anfrage
	60,3	91	56,3			476836	Anfrage	488736	Anfrage
	76,1	106	72,1			476837	Anfrage	488737	Anfrage
	88,9	119	84,3			476838	Anfrage	488738	Anfrage
	114,3	130	109,1			476839	Anfrage	488739	Anfrage
	139,7	155	134,5			476841	Anfrage	488741	Anfrage
	168,3	183	163,1			476842	Anfrage	488742	Anfrage
219,1	233,5	213,9			476844	Anfrage	488744	Anfrage	
<b>C nach Wunsch</b> C on demand									

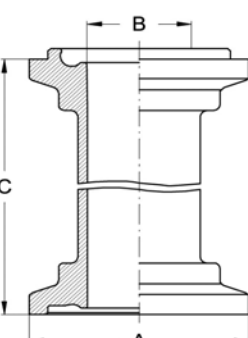
<b>Zwischenstück ISO, NSBS</b> Intermediate piece ISO, NSBS 	DN	A	B			AISI316L-1.4404		AISI316L-1.4435	
	13,5	34	10,3			476929	Anfrage	488829	Anfrage
	17,2	34	14			476930	Anfrage	488830	Anfrage
	21,3	34	18,1			476931	Anfrage	488831	Anfrage
	26,9	50,5	23,7			476932	Anfrage	488832	Anfrage
	33,7	50,5	29,7			476933	Anfrage	488833	Anfrage
	42,4	64	38,4			476934	Anfrage	488834	Anfrage
	48,3	64	44,3			476935	Anfrage	488835	Anfrage
	60,3	91	56,3			476936	Anfrage	488836	Anfrage
	76,1	106	72,1			476937	Anfrage	488837	Anfrage
	88,9	119	84,3			476938	Anfrage	488838	Anfrage
	114,3	130	109,1			476939	Anfrage	488839	Anfrage
	139,7	155	134,5			476941	Anfrage	488841	Anfrage
	168,3	183	163,1			476942	Anfrage	488842	Anfrage
219,1	233,5	213,9			476944	Anfrage	488844	Anfrage	
<b>C nach Wunsch</b> C on demand									

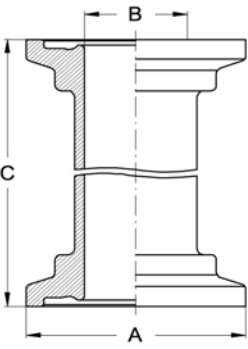
Klemmverbindungen DIN 11864-3 + DIN 11853-3							Art.No.	EUR	Art.No.	EUR
<b>Zwischenstück ISO, BSBS</b> <b>Intermediate piece ISO, BSBS</b>  	DN	A	B				AISI 316L-1.4404		AISI 316L-1.4435	
	13,5	34	10,3				477029	Anfrage	488929	Anfrage
	17,2	34	14				477030	Anfrage	488930	Anfrage
	21,3	34	18,1				477031	Anfrage	488931	Anfrage
	26,9	50,5	23,7				477032	Anfrage	488932	Anfrage
	33,7	50,5	29,7				477033	Anfrage	488933	Anfrage
	42,4	64	38,4				477034	Anfrage	488934	Anfrage
	48,3	64	44,3				477035	Anfrage	488935	Anfrage
	60,3	91	56,3				477036	Anfrage	488936	Anfrage
	76,1	106	72,1				477037	Anfrage	488937	Anfrage
	88,9	119	84,3				477038	Anfrage	488938	Anfrage
	114,3	130	109,1				477039	Anfrage	488939	Anfrage
	139,7	155	134,5				477041	Anfrage	488941	Anfrage
	168,3	183	163,1				477042	Anfrage	488942	Anfrage
	219,1	233,5	213,9				477044	Anfrage	488944	Anfrage
<b>C nach Wunsch</b> <b>C on demand</b>										

C3