

# Rohrverschraubungen DIN 11851 + SMS

Screwed pipe connections DIN 11851 + SMS

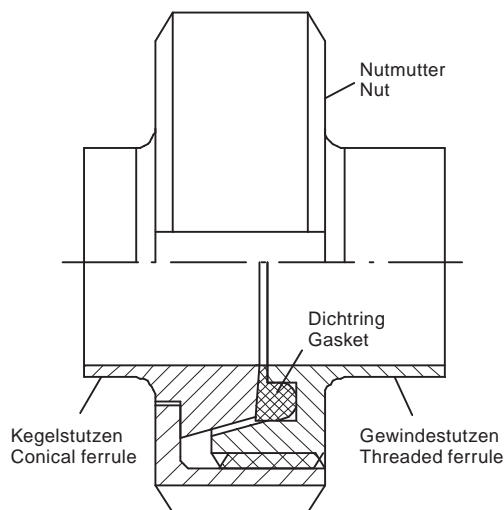

### Einsatzgebiete

Die Rohrverschraubungen werden insbesondere bei verfahrenstechnischen Anlagen für flüssige Medien eingesetzt. Bevorzugte Anwendungsbereiche sind die Lebensmittel- und Getränkeindustrie.

### Montage

Bei der Montage der Rohrverschraubung gemäß DIN 11851 wird der Dichtring in die Nut des Gewindestutzens eingesetzt, wodurch der Dichtring selbsttätig gehalten ist. Dann wird der Kegelstutzen so dagegengesetzt, dass beide Stutzen ineinander greifen. Die Stutzen und der Dichtring sind damit koaxial zwangszentriert. Anschließend wird die Nutmutter über den Kegelstutzen geschoben und auf den Gewindestutzen geschraubt. Dadurch werden die Stutzen fest gegen den Dichtring gepresst, so dass eine dichte Verbindung gegeben ist.

### Merkmale

- Größen: DIN-DN10-200, Zoll 1"- 4", DIN-ISO-DN10-150
- Stutzen: Edelstahl AISI304 und AISI316L
- Oberflächen: Ra innen < 1,6 µm, Ra außen < 3,2 µm
- Dichtringe: NBR, EPDM, VMQ, FKM, PTFE; FDA Konformität
- Nutmutter: Edelstahl AISI304 und AISI316L
- Betriebsdruck: DN10 bis DN40 max. 40 bar (140 °C)  
DN50 bis DN100 max. 25 bar (140 °C)  
DN125 bis DN150 max. 16 bar (140 °C)  
DN200 max. 10 bar (140 °C)

### Application

The screwed pipe connections are used especially with process facilities for liquid media. Preferential fields of application are the food, and beverage industry.

### Assembly

During the assembly of the screwed pipe connection according to DIN 11851 the gasket is put into the groove of the threaded ferrule whereby the gasket is automatically held. Then the conical ferrule is put against so that both ferrules interlock. By this the ferrules and the gasket are coaxially centred. Then the nut is shoved over the conical ferrule and screwed onto the threaded ferrule. Thereby, the ferrules are pressed against the gasket, so that a tight connection is attained.

### Features

- Sizes: DIN-DN10-200, Inch 1"- 4", DIN-ISO-DN10-150
- Ferrules: Stainless steel AISI304 and AISI316L
- Surfaces: Ra inside < 1,6 µm, Ra outside < 3,2 µm
- Gaskets: NBR, EPDM, VMQ, FKM, PTFE; FDA conformity
- Nut: AISI304, AISI316L
- Pressure: DN10 up to DN40 max. 40 bar (140 °C)  
DN50 up to DN100 max. 25 bar (140 °C)  
DN125 up to DN150 max. 16 bar (140 °C)  
DN200 max. 10 bar (140 °C)

### Artikel

Artikel	Seite
Nutmuttern, Dichtringe.....	94
Blindstutzen, Blindkegel, Blindmuttern.....	97
Gewindestutzen, Kegelstutzen.....	101
Reduzier Gewindestutzen, Reduzier Kegelstutzen.....	103
Einschraubstutzen, Aufschraubstutzen.....	104
Schlauchstutzen.....	105
Zwischenstücke.....	107
Kompensatoren, Reduzierstücke.....	108
Bogen, T-Stücke, Kreuzstücke.....	110
Scheibenventile, Kugelventile.....	118
Schrägsitzventile, Drosselventile.....	121
Überströmventile, Rückschlagventile.....	122
Schaulaternen, Schaugläser.....	122
Schmutzfänger, Eckrohrsiebe.....	124
SMS Verschraubungsteile.....	125

### Articles

Articles	Page
Nuts, gaskets.....	94
Blind ferrules, blind nuts.....	97
Threaded ferrules, conical ferrules.....	101
Reducing threaded ferrules, reducing conical ferrules.....	103
Screw-in ferrules, screw-on ferrules.....	104
Hose ferrules.....	105
Intermediate.....	107
Compensators, reducers.....	108
Bends, T-pieces, cross pieces.....	110
Butterfly valves, ball valves.....	118
Inclined seat valves, throttle valves.....	121
Relief angle valves, non-return valves.....	122
Cylinder sight glasses, sight glasses.....	122
Dirt collecting filters, angular filters.....	124
SMS screwed connection pieces.....	125

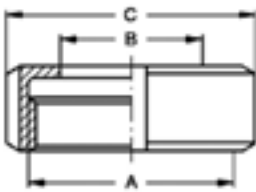
Rohrverschraubungen DIN 11851 + SMS							Art.No.	EUR	Art.No.	EUR
<b>Nutmutter Nut</b>  	DN	A	B	C	Zoll-DN	ISO-DN	AISI304		AISI316L-1.4404	
	10	28x1/8"	19	38	-	10	412130	9,40	412230	12,30
	15	34x1/8"	25	44	-	15	412131	12,50	412231	16,30
	20	44x1/6"	31	54	-	20	412132	11,60	412232	15,40
	25	52x1/6"	36	63	1"	25	412133	11,80	412233	15,80
	32	58x1/6"	43	70	1,25"	32	418134	12,90	418234	16,40
	40	65x1/6"	49	78	1,5"	40	412135	13,20	412235	18,20
	50	78x1/6"	62	92	2"	50	412136	15,90	412236	20,30
	65	95x1/6"	80	112	2,5"	65	412137	23,80	412237	31,50
	3"	104x1/6"	88	119	3"	-	412107	40,40	412207	52,60
	80	110x1/4"	94	127	-	80	412138	37,30	412238	48,90
	100	130x1/4"	115	148	4"	100	412139	50,40	412239	67,10
	125	160x1/4"	141	178	-	125	418141	106,80	418241	120,20
	150	190x1/4"	164	210	-	-	412142	175,60	412242	200,50
	150 ISO	190x1/4"	169	210	-	150	418142	180,70	418242	209,50
200	240x1/4"	214	260	-	-	412144	632,50	412244	829,50	

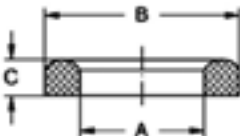
<b>Dichtring Gasket</b>  	DN	A	B	C			NBR		EPDM	
	10	12	20	4,5			421130	0,25	421230	0,35
	15	18	26	4,5			421131	0,25	421231	0,35
	20	23	33	4,5			421132	0,25	421232	0,35
	25/1"	30	40	5			421133	0,35	421233	0,45
	32/1,25"	36	46	5			421134	0,35	421234	0,45
	40/1,5"	42	52	5			421135	0,35	421235	0,45
	50/2"	54	64	5			421136	0,45	421236	0,70
	65/2,5"	71	81	5			421137	0,60	421237	0,90
	3"	78	88	5			421107	1,60	421207	2,10
	80	85	95	5			421138	0,80	421238	1,10
	100/4"	104	114	6			421139	1,10	421239	1,50
	125	130	142	7			421141	1,80	421241	2,70
	150	155	167	7			421142	2,10	421242	3,20
	200	204	216	7			421144	18,50	421244	20,30

DN	A	B	C			VMQ		FKM	
10	12	20	4,5			421330	1,00	421430	2,10
15	18	26	4,5			421331	1,00	421431	2,10
20	23	33	4,5			421332	1,00	421432	2,10
25/1"	30	40	5			421333	1,40	421433	3,20
32/1,25"	36	46	5			421334	1,40	421434	3,20
40/1,5"	42	52	5			421335	1,40	421435	3,20
50/2"	54	64	5			421336	1,80	421436	4,10
65/2,5"	71	81	5			421337	2,10	421437	5,30
3"	78	88	5			421307	4,70	421407	10,50
80	85	95	5			421338	2,70	421438	6,50
100/4"	104	114	6			421339	4,30	421439	10,80
125	130	142	7			421341	5,90	421441	18,40
150	155	167	7			421342	7,40	421442	21,60
200	204	216	7			421344	27,30	421444	75,40

Rohrverschraubungen DIN 11851 + SMS							Art.No.	EUR	Art.No.	EUR
-------------------------------------	--	--	--	--	--	--	---------	-----	---------	-----

**Dichtring  
Gasket**

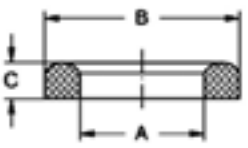

DN	A	B	C					EPDM USP VI	
10	12	20	4,5					420530	Anfrage
15	18	26	4,5					420531	Anfrage
20	23	33	4,5					420532	Anfrage
25/1"	30	40	5					420533	Anfrage
32/1,25"	36	46	5					420534	Anfrage
40/1,5"	42	52	5					420535	Anfrage
50/2"	54	64	5					420536	Anfrage
65/2,5"	71	81	5					420537	Anfrage
3"	78	88	5					420507	Anfrage
80	85	95	5					420538	Anfrage
100/4"	104	114	6					420539	Anfrage
125	130	142	7					420541	Anfrage
150	155	167	7					420542	Anfrage
200	204	216	7					420544	Anfrage

B3

DN	A	B	C					PTFE	
10	12	20	4,5					421530	Anfrage
15	18	26	4,5					421531	Anfrage
20	23	33	4,5					421532	Anfrage
25/1"	30	40	5					421533	Anfrage
32/1,25"	36	46	5					421534	Anfrage
40/1,5"	42	52	5					421535	Anfrage
50/2"	54	64	5					421536	Anfrage
65/2,5"	71	81	5					421537	Anfrage
3"	78	88	5					421507	Anfrage
80	85	95	5					421538	Anfrage
100/4"	104	114	6					421539	Anfrage
125	130	142	7					421541	Anfrage
150	155	167	7					421542	Anfrage
200	204	216	7					421544	Anfrage

**Dichtring, nahtlos ummantelt  
Gasket, seamless enveloped**

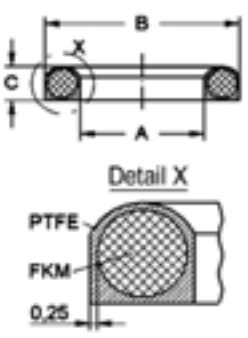

DN	A	B	C					PTFE-FKM	
10	12	20	4,5					420630	34,90
15	18	26	4,5					420631	34,90
20	23	33	5					420632	34,90
25/1"	30	40	5					420633	36,10
32/1,25"	36	46	5					420634	40,50
40/1,5"	42	52	5					420635	44,30
50/2"	54	64	5					420636	44,30
65/2,5"	71	81	5					420637	48,90
3"	78	88	5					420607	57,10
80	85	95	5					420638	60,70
100/4"	104	114	6					420639	68,80
125	130	142	7					420641	89,60
150	155	167	7					420642	117,80

## Rohrverschraubungen DIN 11851 + SMS

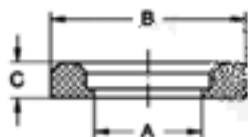
**Art.No.**
**EUR**
**Art.No.**
**EUR**
**Dichtring mit Bund DIN**  
**Gasket with collar DIN**

DN	A	B	C			NBR		EPDM	
10	10,5	20	5			421830	0,90	421930	1,00
15	16,5	26	5			421831	0,90	421931	1,00
20	20,5	33	5			421832	0,90	421932	1,00
25	26,5	40	6			421833	1,20	421933	1,50
32	32,5	46	6			421834	1,20	421934	1,50
40	38,5	52	6			421835	1,20	421935	1,50
50	50,5	64	6			421836	1,40	421936	1,70
65	66,5	81	6			421837	1,80	421937	2,00
80	81,5	95	6			421838	2,10	421938	2,30
100	100,5	114	6			421839	2,80	421939	3,10
125	125	142	7			421841	4,30	421941	5,20
150	150	167	7			421842	5,10	421942	5,80

DN	A	B	C			VMQ		FKM	
10	10,5	20	5			422030	1,30	422130	4,20
15	16,5	26	5			422031	1,30	422131	4,20
20	20,5	33	5			422032	1,30	422132	4,20
25	26,5	40	6			422033	1,70	422133	6,30
32	32,5	46	6			422034	1,70	422134	6,30
40	38,5	52	6			422035	1,70	422135	6,30
50	50,5	64	6			422036	2,40	422136	8,10
65	66,5	81	6			422037	3,00	422137	10,20
80	81,5	95	6			422038	3,40	422138	13,30
100	100,5	114	6			422039	4,80	422139	18,50
125	125	142	7			422041	6,90	422141	30,30
150	150	167	7			422042	8,20	422142	32,40

DN	A	B	C			PTFE	
10	10,5	20	5			422230	Anfrage
15	16,5	26	5			422231	Anfrage
20	20,5	33	5			422232	Anfrage
25	26,5	40	6			422233	Anfrage
32	32,5	46	6			422234	Anfrage
40	38,5	52	6			422235	Anfrage
50	50,5	64	6			422236	Anfrage
65	66,5	81	6			422237	Anfrage
80	81,5	95	6			422238	Anfrage
100	100,5	114	6			422239	Anfrage
125	125	142	7			422241	Anfrage
150	150	167	7			422242	Anfrage

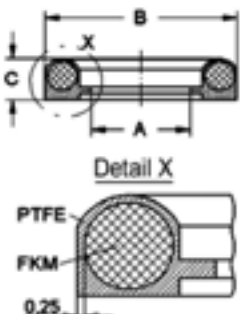
Rohrverschraubungen DIN 11851 + SMS						Art.No.	EUR	Art.No.	EUR
Dichtring mit Bund nahtlos ummantelt Gasket with collar seamless envelope  	DN	A	B	C				PTFE-FKM	
	10	10,5	20	5,5				420730	39,60
	15	16,5	26	5,5				420731	39,60
	20	20,5	33	6				420732	39,60
	25	26,5	40	6				420733	41,40
	32	32,5	46	6				420734	44,10
	40	38,5	52	6				420735	46,80
	50	50,5	64	6				420736	51,10
	65	66,5	81	6				420737	56,70
	80	81,5	95	6				420738	64,80
	100	100,5	114	7				420739	79,20

B3

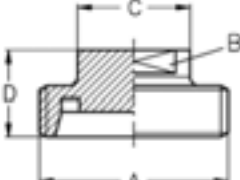
Blindgewindestutzen Blind threaded ferrule						AISI304		AISI316L-1.4404		
	DN	A	B	C	D					
	10	28x1/8"	SW19	22	22		412330	31,80	412430	41,30
	15	34x1/8"	SW22	25	22		412331	34,40	412431	44,50
	20	44x1/6"	SW22	25	24		412332	35,90	412432	48,30
	25/1"	52x1/6"	SW27	34	24		412333	39,50	412433	66,60
	32/1,25"	58x1/6"	SW27	34	24		412334	42,60	412434	81,80
	40/1,5"	65x1/6"	SW27	34	24		412335	50,90	412435	90,90
	50/2"	78x1/6"	SW27	34	24		412336	49,90	412436	112,80
	65/2,5"	95x1/6"	SW27	34	26		412337	116,30	412437	133,80
	3"	104x1/6"	SW27	34	26		412307	160,20	412407	Anfrage
	80	110x1/4"	SW27	34	30		412338	138,90	412438	184,60
100/4"	130x1/4"	SW27	34	30		412339	183,70	412439	245,20	

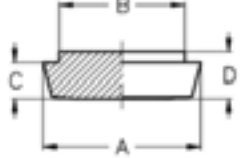
Blindkegel Blind cone						AISI304		AISI316L-1.4404		
	DN	A	B	C	D					
	10	22	18	6	9		412530	9,80	412630	12,70
	15	28	24	6	9		412531	11,30	412631	14,70
	20	36	30	8	11		412532	14,90	412632	19,60
	25/1"	44	35	10	13		412533	12,60	412633	17,50
	32/1,25"	50	41	10	13		412534	16,40	412634	21,90
	40/1,5"	56	48	10	13		412535	17,30	412635	22,60
	50/2"	68	61	11	14		412536	21,80	412636	28,20
	65/2,5"	86	79	12	16		412537	31,80	412637	41,60
	3"	93	86	12	16		412507	43,60	412607	56,90
	80	100	93	12	16		412538	42,20	412638	53,80
	100/4"	121	114	15	20		412539	59,30	412639	91,70
	125	150	137	17	22		412541	123,70	412641	164,80
150	176	163	18	24		412542	170,80	412642	251,30	

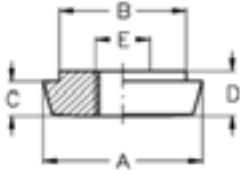
Rohrverschraubungen DIN 11851 + SMS							Art.No.	EUR	Art.No.	EUR
<b>Blindkegel mit Rohrgewinde</b> <b>Blind cone with female thread</b>  	DN	A	B	C	D		AISI304		AISI316L-1.4404	
	10	22	18	6	9		417830	30,50	417930	33,40
	15	28	24	6	9		417831	31,80	417931	35,70
	20	36	30	8	11		417832	36,70	417932	41,30
	25/1"	44	35	10	13		417833	32,20	417933	35,90
	32/1,25"	50	41	10	13		417834	38,40	417934	43,70
	40/1,5"	56	48	10	13		417835	39,30	417935	44,50
	50/2"	68	61	11	14		417836	44,50	417936	50,80
	65/2,5"	86	79	12	16		417837	56,70	417937	66,40
	3"	93	86	12	16		417807	70,20	417907	83,40
	80	100	93	12	16		417838	68,40	417938	80,60
	100/4"	121	114	15	20		417839	90,80	417939	113,10
	125	150	137	17	22		417841	147,30	417941	187,90
	150	176	163	18	24		417842	196,60	417942	277,40
<b>Gewinde E auf Anfrage</b> <b>Thread E on demand</b>										

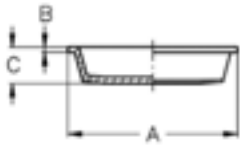
<b>Blechblindkegel</b> <b>Blind cone, sheet metal type</b>  	DN	A	B	C			AISI304		AISI316L-1.4404	
	25/1"	47	1,5	10			412733	5,40	412833	7,10
	32/1,25"	53	1,5	10			412734	5,80	412834	7,60
	40/1,5"	61	1,5	10			412735	5,90	412835	7,90
	50/2"	73	1,5	11			412736	6,90	412836	9,20
	65/2,5"	90	1,5	12			412737	8,70	412837	11,30
	3"	99	1,5	12			412707	14,10	412807	18,10
	80	103	1,5	12			412738	12,70	412838	16,10
	100/4"	123	1,5	15			412739	16,30	412839	19,70
	125	153	2	17			412741	24,90	412841	34,30
	150	183	2	18			412742	42,80	412842	55,60

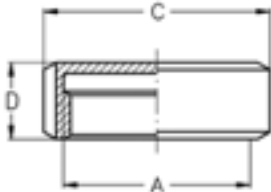
<b>Blindmutter</b> <b>Blind nut</b>  	DN	A	C	D			AISI304		AISI316L-1.4404	
	10	28x1/8"	38	18			417330	23,10	417430	33,30
	15	34x1/8"	44	18			417331	23,30	417431	33,80
	20	44x1/6"	54	20			417332	23,90	417432	37,20
	25/1"	52x1/6"	63	21			417333	18,80	417433	29,30
	32/1,25"	58x1/6"	70	21			417334	19,60	417434	38,40
	40/1,5"	65x1/6"	78	21			417335	20,40	417435	30,20
	50/2"	78x1/6"	92	22			417336	23,10	417436	35,60
	65/2,5"	95x1/6"	112	25			417337	32,60	417437	45,80
	3"	104x1/6"	119	25			417307	55,70	417407	Anfrage
	80	110x1/4"	127	30			417338	49,80	417438	82,40
	100/4"	130x1/4"	148	31			417339	71,30	417439	91,20
	125	160x1/4"	178	34			417341	140,70	417441	307,40
	150	190x1/4"	210	39			417342	426,50	417442	Anfrage
200	240x1/4"	260	39,5			417344	836,30	417444	Anfrage	

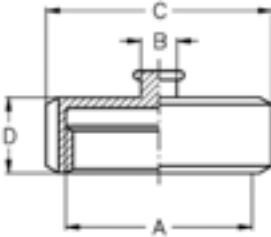
Rohrverschraubungen DIN 11851 + SMS							Art.No.	EUR	Art.No.	EUR
Blindmutter mit Knopf für Kette Blind nut with button for chain  	DN	A	B	C	D		AISI304		AISI316L-1.4404	
	10	28x1/8"	10	38	18		412930	27,10	413030	26,10
	15	34x1/8"	10	44	18		412931	25,70	413031	37,20
	20	44x1/6"	10	54	20		412932	25,10	413032	38,90
	25/1"	52x1/6"	10	63	21		412933	24,60	413033	30,60
	32/1,25"	58x1/6"	10	70	21		412934	22,30	413034	39,50
	40/1,5"	65x1/6"	10	78	21		412935	22,80	413035	32,40
	50/2"	78x1/6"	10	92	22		412936	25,90	413036	38,30
	65/2,5"	95x1/6"	10	112	25		412937	34,40	413037	47,20
	3"	104x1/6"	10	119	25		412907	55,80	413007	Anfrage
	80	110x1/4"	10	127	30		412938	52,50	413038	84,50
	100/4"	130x1/4"	10	148	31		412939	71,20	413039	90,60
	125	160x1/4"	10	178	34		412941	150,40	413041	316,80
	150	190x1/4"	10	210	39		412942	435,50	413042	610,70

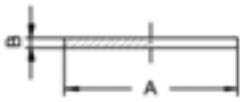
Dichtscheibe für Blindmutter Sealing disk for blind nut  	DN	A	B				NBR		EPDM	
	10	28	3				422430	0,70	422530	1,10
	15	34	3				422431	0,60	422531	1,40
	20	44	3				422432	0,60	422532	1,60
	25/1"	52	3				422433	0,70	422533	1,70
	32/1,25"	58	3				422434	1,10	422534	2,00
	40/1,5"	65	3				422435	0,90	422535	2,20
	50/2"	78	3				422436	1,10	422536	2,30
	65/2,5"	95	3				422437	1,40	422537	2,40
	3"	104	3				422407	1,50	422507	3,30
	80	110	3				422438	2,00	422538	3,40
	100/4"	130	3				422439	3,30	422539	4,10
	125	160	3				422441	4,70	422541	4,90
	150	190	3				422442	5,40	422542	6,40
200	240	3				422444	23,80	422544	Anfrage	

DN	A	B				FKM		PTFE	
10	28	3				422630	3,60	422730	Anfrage
15	34	3				422631	4,20	422731	Anfrage
20	44	3				422632	5,40	422732	Anfrage
25/1"	52	3				422633	6,90	422733	Anfrage
32/1,25"	58	3				422634	7,10	422734	Anfrage
40/1,5"	65	3				422635	12,60	422735	Anfrage
50/2"	78	3				422636	17,30	422736	Anfrage
65/2,5"	95	3				422637	19,60	422737	Anfrage
3"	104	3				422607	23,60	422707	Anfrage
80	110	3				422638	22,30	422738	Anfrage
100/4"	130	3				422639	32,20	422739	Anfrage
125	160	3				422641	46,60	422741	Anfrage
150	190	3				422642	63,70	422742	Anfrage
200	240	3				422644	Anfrage	422744	Anfrage

Rohrverschraubungen DIN 11851 + SMS							Art.No.	EUR	Art.No.	EUR
<b>Kette mit Öse und S-Haken</b> Chain with eye and hook  	DN	A					AISI304			
	10	90							413130	3,40
	15	90							413131	3,40
	20	90							413132	3,40
	25/1"	130							413133	3,80
	32/1,25"	140							413134	4,00
	40/1,5"	150							413135	4,10
	50/2"	160							413136	4,80
	65/2,5"	170							413137	4,00
	80/3"	190							413138	8,20
	100/4"	200							413139	9,10
	125	290							413141	10,80
150	320							413142	12,10	

<b>Kette mit zwei S-Haken</b> Chain with two hooks  	DN	A					AISI304			
	10	160							413230	2,80
	15	190							413231	3,00
	20	230							413232	3,20
	25/1"	240							413233	3,30
	32/1,25"	260							413234	3,40
	40/1,5"	300							413235	3,90
	50/2"	350							413236	4,10
	65/2,5"	400							413237	4,40
	80/3"	460							413238	7,20
	100/4"	550							413239	8,70
	125	650							413241	9,40
150	750							413242	10,60	

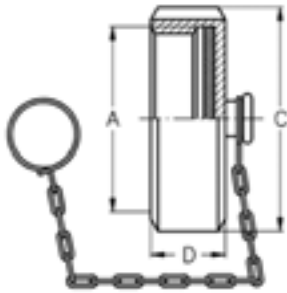
<b>Blindmutter komplett</b> Blind nut complete  	DN	A	C	D			AISI304		AISI316L-1.4404	
	10	28x1/8"	38	18			417530	30,20	417630	39,80
	15	34x1/8"	44	18			417531	29,30	417631	40,60
	20	44x1/6"	54	20			417532	27,50	417632	42,30
	25/1"	52x1/6"	63	21			417533	25,40	417633	35,10
	32/1,25"	58x1/6"	70	21			417534	27,10	417634	45,90
	40/1,5"	65x1/6"	78	21			417535	26,60	417635	36,90
	50/2"	78x1/6"	92	22			417536	31,50	417636	45,30
	65/2,5"	95x1/6"	112	25			417537	40,60	417637	53,60
	3"	104x1/6"	119	25			417507	63,50	417607	Anfrage
	80	110x1/4"	127	30			417538	59,80	417638	93,10
	100/4"	130x1/4"	148	31			417539	82,60	417639	101,20
	125	160x1/4"	178	34			417541	163,40	417641	332,50
	150	190x1/4"	210	39			417542	454,50	417642	632,40

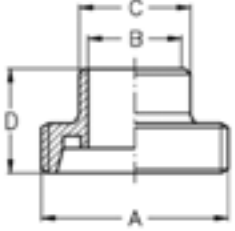

Rohrverschraubungen DIN 11851 + SMS							Art.No.	EUR	Art.No.	EUR
<b>Gewindestutzen DIN</b> <b>Threaded ferrule DIN</b>  	DN	A	B	C	D		AISI304		AISI316L-1.4404	
	10	28x1/8"	10	15	21		410330	9,10	410430	11,80
	15	34x1/8"	16	21	21		410331	10,10	410431	13,10
	20	44x1/6"	20	25	24		410332	11,90	410432	15,70
	25	52x1/6"	26	31	29		410333	11,30	410433	15,10
	32	58x1/6"	32	37	32		410334	12,70	410434	17,40
	40	65x1/6"	38	43	33		410335	13,60	410435	18,10
	50	78x1/6"	50	55	35		410336	15,70	410436	20,80
	65	95x1/6"	66	72	40		410337	23,60	410437	31,30
	80	110x1/4"	81	87	45		410338	36,10	410438	47,10
	100	130x1/4"	100	106	54		410339	53,80	410439	71,40
	125	160x1/4"	125	132	46		410341	97,20	410441	141,60
	150	190x1/4"	150	157	50		410342	151,50	410442	182,90
200	240x1/4"	200	213	50		410344	703,60	410444	937,80	

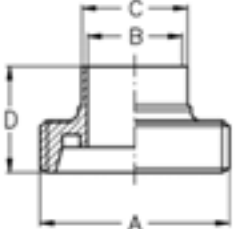
<b>Gewindestutzen DIN 11851</b> <b>Threaded ferrule DIN 11851</b>  	DN	A	B	C	D		AISI304		AISI316L-1.4404	
	10	28x1/8"	10	13	21		410130	9,10	410230	11,80
	15	34x1/8"	16	19	21		410131	10,10	410231	13,10
	20	44x1/6"	20	23	24		410132	11,90	410232	15,70
	25	52x1/6"	26	29	29		410133	11,30	410233	15,10
	32	58x1/6"	32	35	32		410134	12,70	410234	17,40
	40	65x1/6"	38	41	33		410135	13,60	410235	18,10
	50	78x1/6"	50	53	35		410136	15,70	410236	20,80
	65	95x1/6"	66	70	40		410137	23,60	410237	31,30
	80	110x1/4"	81	85	45		410138	36,10	410238	47,10
	100	130x1/4"	100	104	54		410139	53,80	410239	71,40
	125	160x1/4"	125	129	46		410141	97,20	410241	141,60
	150	190x1/4"	150	154	50		410142	151,50	410242	182,90
200	240x1/4"	200	204	50		410144	Anfrage	410244	Anfrage	

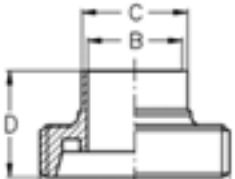
<b>Gewindestutzen Zoll</b> <b>Threaded ferrule inch</b>  	DN	A	B	C	D		AISI304		AISI316L-1.4404	
	1"	52x1/6"	22,9	25,4	29		411103	11,70	411203	15,80
	1,25"	58x1/6"	29,3	31,8	32		411113	13,70	411213	18,10
	1,5"	65x1/6"	35,1	38,1	33		411104	14,40	411204	19,10
	2"	78x1/6"	47,8	50,8	35		411105	16,50	411205	21,50
	2,5"	95x1/6"	60,5	63,5	40		411106	25,80	411206	32,70
	3"	104x1/6"	73,1	76,1	40		411107	37,70	411207	44,70
	4"	130x1/4"	97,6	101,6	54		411108	61,50	411208	81,30

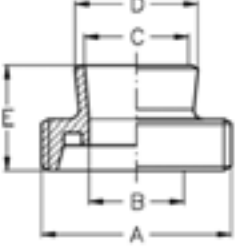
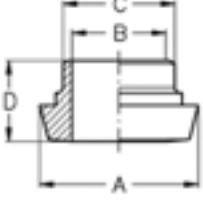
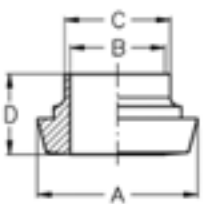
Rohrverschraubungen DIN 11851 + SMS							Art.No.	EUR	Art.No.	EUR
<b>Gewindestutzen DIN-ISO</b> <b>Threaded ferrule DIN-ISO</b> 	<b>DN</b>	<b>A</b>	<b>B</b>	<b>C</b>	<b>D</b>	<b>E</b>	<b>AISI304</b>		<b>AISI316L-1.4404</b>	
	10	28x1/8"	10	14	17,2	21	417130	17,90	417230	27,30
	15	34x1/8"	16	18,1	21,3	21	417131	17,90	417231	27,30
	20	44x1/6"	20	23,7	26,9	24	417132	17,90	417232	27,30
	25	52x1/6"	26	29,7	33,7	29	417133	19,20	417233	28,40
	32	58x1/6"	32	38,4	42,4	32	417134	20,60	417234	30,30
	40	65x1/6"	38	44,3	48,3	33	417135	21,40	417235	31,50
	50	78x1/6"	50	56,3	60,3	35	417136	23,20	417236	34,80
	65	95x1/6"	66	71,5	76,1	40	417137	34,80	417237	51,60
	80	110x1/4"	81	84,3	88,9	45	417138	49,20	417238	73,20
	100	130x1/4"	100	109,1	114,3	54	417139	65,40	417239	96,60
	125	160x1/4"	125	134,5	139,7	46	417141	142,80	417241	192,40
150	190x1/4"	150	163,1	168,3	49	417142	219,90	417242	318,80	
<b>Kegelstutzen DIN</b> <b>Conical ferrule DIN</b> 	<b>DN</b>	<b>A</b>	<b>B</b>	<b>C</b>	<b>D</b>		<b>AISI304</b>		<b>AISI316L-1.4404</b>	
	10	22	10	15	17		411330	4,60	411430	5,90
	15	28	16	21	17		411331	6,10	411431	8,10
	20	36	20	25	18		411332	7,10	411432	9,40
	25	44	26	31	22		411333	8,10	411433	10,10
	32	50	32	37	25		411334	8,70	411434	11,50
	40	56	38	43	26		411335	9,80	411435	12,40
	50	68	50	55	28		411336	11,50	411436	14,90
	65	86	66	72	32		411337	16,40	411437	21,60
	80	100	81	87	37		411338	26,20	411438	33,80
	100	121	100	106	44		411339	40,40	411439	52,70
	125	150	125	132	34		411341	78,20	411441	114,60
150	176	150	157	37		411342	159,90	411442	172,60	
200	226	200	213	39		411344	549,70	411444	759,90	
<b>Kegelstutzen DIN 11851</b> <b>Conical ferrule DIN 11851</b> 	<b>DN</b>	<b>A</b>	<b>B</b>	<b>C</b>	<b>D</b>		<b>AISI304</b>		<b>AISI316L-1.4404</b>	
	10	22	10	13	17		416530	4,60	416630	5,90
	15	28	16	19	17		416531	6,10	416631	8,10
	20	36	20	23	18		416532	7,30	416632	9,40
	25	44	26	29	22		416533	8,30	416633	10,10
	32	50	32	35	25		416534	8,70	416634	11,50
	40	56	38	41	26		416535	9,70	416635	12,10
	50	68	50	53	28		416536	11,50	416636	15,00
	65	86	66	70	32		416537	16,50	416637	21,70
	80	100	81	85	37		416538	26,20	416638	33,90
	100	121	100	104	44		416539	40,70	416639	52,70
	125	150	125	129	34		416541	78,40	416641	114,50
150	176	150	154	37		416542	159,80	416642	189,80	
200	226	200	204	39		416544	Anfrage	416644	Anfrage	

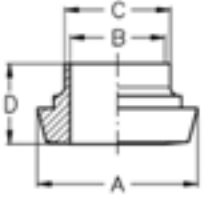
Rohrverschraubungen DIN 11851 + SMS							Art.No.	EUR	Art.No.	EUR
<b>Kegelstutzen Zoll</b> <b>Conical ferrule inch</b> 	DN	A	B	C	D		AISI304		AISI316L-1.4404	
	1"	44	22,9	25,4	22		416703	8,10	416803	9,80
	1,25"	50	29,3	31,8	25		416713	9,30	416813	11,80
	1,5"	56	35,1	38,1	26		416704	9,90	416804	13,10
	2"	68	47,8	50,8	28		416705	11,40	416805	14,10
	2,5"	86	60,5	63,5	32		416706	19,20	416806	24,90
	3"	93	72,1	76,1	32		416707	32,60	416807	43,20
	4"	121	97,6	101,6	44		416708	44,40	416808	48,10

B3

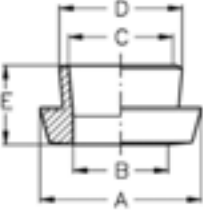
<b>Kegelstutzen DIN-ISO</b> <b>Conical ferrule DIN-ISO</b> 	DN	A	B	C	D	E	AISI304		AISI316L-1.4404	
	10	22	10	14	17,2	17	416930	12,50	417030	18,40
	15	28	16	18,1	21,3	17	416931	12,50	417031	18,40
	20	36	20	23,7	26,9	18	416932	12,50	417032	18,40
	25	44	26	29,7	33,7	22	416933	16,90	417033	24,80
	32	50	32	38,4	42,4	25	416934	17,60	417034	26,30
	40	56	38	44,3	48,3	26	416935	18,20	417035	27,30
	50	68	50	56,3	60,3	28	416936	20,80	417036	31,40
	65	86	66	71,5	76,1	32	416937	24,90	417037	38,10
	80	100	81	84,3	88,9	37	416938	36,10	417038	56,30
	100	121	100	109,1	114,3	44	416939	55,70	417039	83,50
	125	150	125	134,5	139,7	34	416941	121,90	417041	204,20
150	176	150	163,1	168,3	37	416942	212,70	417042	307,90	

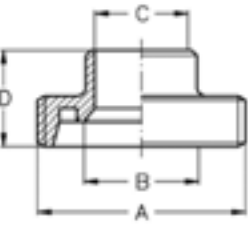
<b>Red.-Gewindestutzen</b> <b>Red. threaded ferrule</b> 	DN	A	B	C	D		AISI304		AISI316L-1.4404	
	20-15	44x1/6"	20	16	24		413361	78,60	413461	100,30
	25-15	52x1/6"	26	16	29		413363	70,80	413463	95,40
	25-20	52x1/6"	26	20	29		413364	49,40	413464	68,90
	32-20	58x1/6"	32	20	27		413366	68,00	413466	91,20
	32-25	58x1/6"	32	26	27		413367	24,50	413467	31,10
	40-25	65x1/6"	38	26	28		413370	28,20	413470	37,20
	40-32	65x1/6"	38	32	29		413371	29,10	413471	39,10
	50-25	78x1/6"	50	26	26		413372	45,00	413472	58,70
	50-32	78x1/6"	50	32	29		413373	31,60	413473	41,40
	50-40	78x1/6"	50	38	35		413374	31,20	413474	40,50
	65-32	95x1/6"	66	32	39		413376	117,90	413476	153,80
	65-40	95x1/6"	66	38	39		413377	79,90	413477	105,50
	65-50	95x1/6"	66	50	40		413378	46,70	413478	59,60
	80-40	110x1/4"	81	38	43		413381	162,50	413481	215,40
	80-50	110x1/4"	81	50	45		413382	146,90	413482	188,60
	80-65	110x1/4"	81	66	46		413383	103,80	413483	135,80
	100-50	130x1/4"	100	50	49		413384	232,90	413484	302,80
100-65	130x1/4"	100	66	49		413385	215,40	413485	278,90	
100-80	130x1/4"	100	81	49		413386	218,80	413486	283,30	

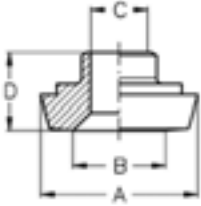
Rohrverschraubungen DIN 11851 + SMS							Art.No.	EUR	Art.No.	EUR
<b>Red.-Kegelstutzen</b> <b>Red. conical ferrule</b>  	DN	A	B	C	D		AISI304		AISI316L-1.4404	
	20-15	36,5	20	16	17		413761	22,80	413861	31,50
	25-15	44	26	16	22		413763	23,50	413863	32,50
	25-20	44	26	20	22		413764	22,60	413864	31,30
	32-15	50	32	16	23		413765	38,30	413865	47,10
	32-20	50	32	20	23		413766	38,30	413866	47,10
	32-25	50	32	26	20		413767	21,90	413867	34,10
	40-15	56	38	16	25		413768	65,80	413868	82,30
	40-20	56	38	20	25		413769	65,80	413869	82,30
	40-25	56	38	26	20		413770	24,30	413870	31,80
	40-32	56	38	32	23		413771	24,30	413871	31,80
	50-25	68	50	26	28		413772	41,60	413872	56,10
	50-32	68	50	32	23		413773	34,40	413873	56,10
	50-40	68	50	38	26		413774	27,17	413874	31,80
	65-25	86	66	26	32		413775	86,90	413875	108,60
	65-32	86	66	32	32		413776	86,90	413876	108,60
	65-40	86	66	38	26		413777	42,30	413877	54,90
	65-50	86	66	50	27		413778	35,10	413878	43,50
	80-40	100	81	38	36		413781	109,90	413881	142,60
	80-50	100	81	50	30		413782	65,60	413882	85,20
	80-65	100	81	66	31		413783	57,70	413883	67,80
100-50	121	100	50	40		413784	174,70	413884	235,70	
100-65	121	100	66	40		413785	136,10	413885	188,60	
100-80	121	100	81	42		413786	119,80	413886	164,20	
125-100	150	125	100	56		413789	354,00	413889	Anfrage	
150-100	176	150	100	50		413791	458,00	413891	Anfrage	

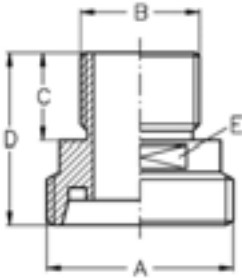
<b>Gewindeinschraubstutzen</b> <b>Male threaded outside</b>  	DN	A	B	C	D	E	AISI304		AISI316L-1.4404	
	10	28x1/8"	G 3/8"	14	40	SW 17	414530	25,20	414630	41,60
	15	34x1/8"	G 1/2"	14	40	SW 24	414531	25,90	414631	42,80
	20	44x1/6"	G3/4"	14	42	SW 30	414532	33,00	414632	54,40
	25	52x1/6"	G1"	20	48	SW 41	414533	38,50	414633	63,90
	32	58x1/6"	G 1,25"	20	48	SW 46	414534	42,40	414634	67,40
	40	65x1/6"	G1,5"	20	50	SW 50	414535	46,60	414635	70,30
	50	78x1/6"	G 2"	20	52	SW 65	414536	59,30	414636	86,40
	65	95x1/6"	G 2,5"	22	56	SW 80	414537	88,00	414637	127,90
	80	110x1/4"	G 3"	25	66	SW 95	414538	136,60	414638	246,20
	100	130x1/4"	G 4"	30	72	SW 117	414539	274,30	414639	Anfrage

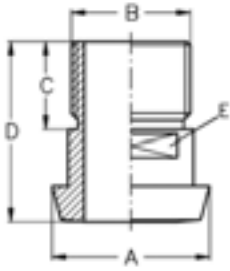
Rohrverschraubungen DIN 11851 + SMS							Art.No.	EUR	Art.No.	EUR
<b>Kegeleinschraubstutzen</b> Conical screw-in ferrule 	DN	A	B	C	D	E	AISI304		AISI316L-1.4404	
	10	22	G 3/8"	14	38	SW 14	414730	29,10	414830	45,90
	15	28	G 1/2"	14	38	SW 19	414731	29,10	414831	45,90
	20	36	G 3/4"	14	40	SW 27	414732	29,10	414832	45,90
	25	44	G 1"	20	50	SW 30	414733	29,60	414833	47,20
	32	50	G 1,25"	20	50	SW 36	414734	34,80	414834	48,30
	40	56	G 1,5"	20	50	SW 44	414735	36,40	414835	56,30
	50	68	G 2"	20	50	SW 55	414736	44,50	414836	66,40
	65	86	G 2,5"	22	55	SW 70	414737	75,60	414837	112,70
	80	100	G 3"	25	60	SW 88	414738	115,30	414838	191,20
100	121	G 4"	30	70	SW 110	414739	169,30	414839	264,30	

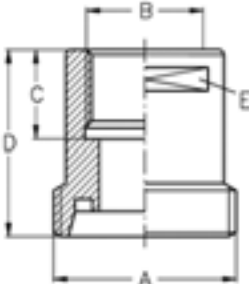
<b>Gewindeaufschraubstutzen</b> Male threaded inside 	DN	A	B	C	D	E	AISI304		AISI316L-1.4404	
	10	28x1/8"	G 3/8"	14	30	SW 19	414930	36,10	415030	58,80
	15	34x1/8"	G 1/2"	14	30	SW 24	414931	36,10	415031	58,80
	20	44x1/6"	G 3/4"	14	30	SW 30	414932	36,10	415032	58,80
	25	52x1/6"	G 1"	20	35	SW 41	414933	38,40	415033	59,90
	32	58x1/6"	G 1,25"	20	35	SW 46	414934	42,40	415034	61,50
	40	65x1/6"	G 1,5"	20	35	SW 50	414935	43,40	415035	64,10
	50	78x1/6"	G 2"	20	35	SW 65	414936	58,90	415036	70,90
	65	95x1/6"	G 2,5"	22	38	SW 80	414937	79,80	415037	118,10
	80	110x1/4"	G 3"	25	43	SW 95	414938	214,80	415038	306,80
100	130x1/4"	G 4"	30	50	SW 117	414939	279,90	415039	401,70	

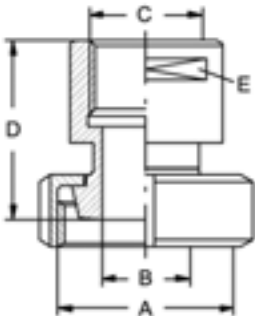
<b>Kegelaufschraubstutzen</b> Conical screw-on ferrule 	DN	A	B	C	D	E	AISI304		AISI316L-1.4404	
	10	28x1/8"	10	G 3/8"	39	SW 19	415130	82,20	415230	123,90
	15	34x1/8"	16	G 1/2"	41	SW 24	415131	82,20	415231	123,90
	20	44x1/6"	20	G 3/4"	42	SW 30	415132	82,20	415232	123,90
	25	52x1/6"	26	G 1"	52	SW 41	415133	86,30	415233	126,60
	32	58x1/6"	32	G 1,25"	55	SW 46	415134	94,50	415234	142,50
	40	65x1/6"	38	G 1,5"	56	SW 50	415135	96,30	415235	145,70
	50	78x1/6"	50	G 2"	58	SW 65	415136	101,10	415236	149,90
	65	95x1/6"	66	G 2,5"	64	SW 80	415137	176,60	415237	261,40
	80	110x1/4"	81	G 3"	74	SW 95	415138	217,70	415238	278,90
100	130x1/4"	100	G 4"	89	SW 117	415139	309,50	415239	452,00	

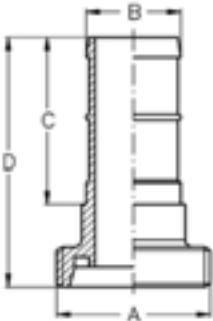
<b>Schlauchgewindestutzen</b> Threaded hose ferrule 	DN	A	B	C	D	AISI304		AISI316L-1.4404	
	10	28x1/8"	15	31	54	415330	39,40	415430	61,20
	15	34x1/8"	21	40	64	415331	39,40	415431	61,20
	20	44x1/6"	27	47	76	415332	39,40	415432	61,20
	25	52x1/6"	32	57	87	415333	43,30	415433	66,70
	32	58x1/6"	40	67	97	415334	48,30	415434	75,40
	40	65x1/6"	48	81	112	415335	62,50	415435	98,60
	50	78x1/6"	58	95	127	415336	75,40	415436	111,00
	65	95x1/6"	76	112	148	415337	107,20	415437	181,20
	80	110x1/4"	90	127	168	415338	159,40	415438	267,90
100	130x1/4"	110	146	190	415339	234,20	415439	393,40	

Rohrverschraubungen DIN 11851 + SMS							Art.No.	EUR	Art.No.	EUR
<b>Schlauchgewindestutzen Rohr</b> Threaded hose ferrule pipe 	DN	A	B	C	D		AISI304		AISI316L-1.4404	
	15	34x1/8"	16	19,5	67		415531	31,70	415631	50,90
	20	44x1/6"	20	23,5	69		415532	31,70	415632	50,90
	25	52x1/6"	26	29,5	82		415533	33,40	415633	39,90
	32	58x1/6"	32	36	92		415534	34,80	415634	40,90
	40	65x1/6"	38	42	102		415535	36,10	415635	41,70
	50	78x1/6"	50	54	113		415536	39,50	415636	47,80
	65	95x1/6"	66	72	125		415537	50,30	415637	71,40
	80	110x1/4"	81	88	135		415538	74,30	415638	124,70
	100	130x1/4"	100	107	150		415539	104,10	415639	175,00

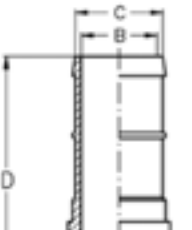
<b>Schlauchgewindestutzen Bier</b> Threaded hose ferrule beer 	DN	A	B	C	D		AISI304		AISI316L-1.4404	
	25	52x1/6"	24	27	87		415733	40,20	415833	62,10
	32	58x1/6"	31	34	97		415734	49,90	415834	80,20
	40	65x1/6"	32	43	112		415735	62,60	415835	95,50
	50	78x1/6"	45	53	127		415736	67,60	415836	102,50
	65	95x1/6"	60	68	148		415737	91,90	415837	122,80
	80	110x1/4"	74	83	168		415738	200,10	415838	270,00
	100	130x1/4"	93	103	190		415739	254,40	415839	340,40

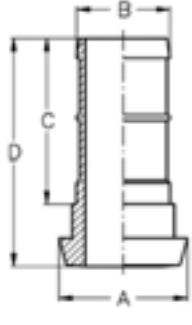
<b>Schlauchkegelstutzen</b> Conical hose ferrule 	DN	A	B	C	D		AISI304		AISI316L-1.4404	
	10	22	15	31	50		415930	36,50	416030	59,70
	15	28	21	40	60		415931	36,50	416031	59,70
	20	36	27	47	70		415932	36,50	416032	59,70
	25	44	32	57	80		415933	38,40	416033	63,20
	32	50	40	67	90		415934	45,70	416034	70,90
	40	56	48	81	105		415935	58,10	416035	91,80
	50	68	58	95	120		415936	68,80	416036	105,60
	65	86	76	112	140		415937	99,80	416037	126,10
	80	100	90	127	160		415938	148,10	416038	229,70
100	121	110	146	180		415939	218,80	416039	305,90	

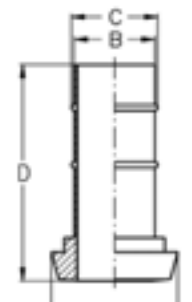
<b>Schlauchkegelstutzen Rohr</b> Conical hose ferrule pipe 	DN	A	B	C	D		AISI304		AISI316L-1.4404	
	15	28	18	19,5	63		416131	26,90	416231	43,30
	20	36	22	23,5	63		416132	26,90	416232	43,90
	25	44	28	29,5	75		416133	27,70	416233	34,10
	32	50	34	36	85		416134	28,50	416234	38,30
	40	56	40	42	95		416135	28,90	416235	38,90
	50	68	52	54	106		416136	32,40	416236	43,50
	65	86	70	72	117		416137	43,80	416237	65,90
	80	100	85	88	127		416138	62,60	416238	106,20
	100	121	104	107	140		416139	98,80	416239	166,50

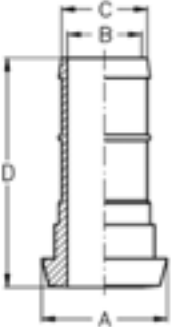
Rohrverschraubungen DIN 11851 + SMS							Art.No.	EUR	Art.No.	EUR
<b>Schlauchkegelstutzen Bier</b> <b>Conical hose ferrule beer</b> 	DN	A	B	C	D		AISI304		AISI316L-1.4404	
	25	44	24	27	80		416333	36,20	416433	56,10
	32	50	31	34	90		416334	46,30	416434	70,70
	40	56	32	42,5	105		416335	59,20	416435	88,90
	50	68	45	53	120		416336	66,20	416436	94,10
	65	86	60	68	140		416337	87,90	416437	116,20
	80	100	74	83	164		416338	189,80	416438	251,60
	100	121	93	103	180		416339	235,90	416439	312,80

B3

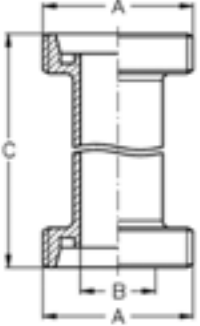
<b>Zwischenstück GG</b> <b>Intermediate piece GG</b> 	DN	A	B				AISI304		AISI316L-1.4404	
	10	28x1/8"	10				430930	Anfrage	431030	Anfrage
	15	34x1/8"	16				430931	Anfrage	431031	Anfrage
	20	44x1/6"	20				430932	Anfrage	431032	Anfrage
	25	52x1/6"	26				430933	Anfrage	431033	Anfrage
	32	58x1/6"	32				430934	Anfrage	431034	Anfrage
	40	65x1/6"	38				430935	Anfrage	431035	Anfrage
	50	78x1/6"	50				430936	Anfrage	431036	Anfrage
	65	95x1/6"	66				430937	Anfrage	431037	Anfrage
	80	110x1/4"	81				430938	Anfrage	431038	Anfrage
	100	130x1/4"	100				430939	Anfrage	431039	Anfrage
	125	160x1/4"	125				430941	Anfrage	431041	Anfrage
	150	190x1/4"	150				430942	Anfrage	431042	Anfrage
	200	240x1/4"	200				430944	Anfrage	431044	Anfrage
<b>C nach Wunsch</b> <b>C on demand</b>										

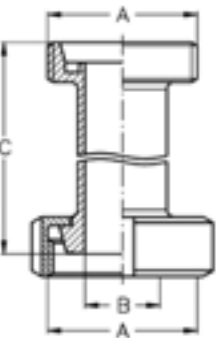
<b>Zwischenstück GK</b> <b>Intermediate piece GK</b> 	DN	A	B				AISI304		AISI316L-1.4404	
	10	28x1/8"	10				432130	Anfrage	432230	Anfrage
	15	34x1/8"	16				432131	Anfrage	432231	Anfrage
	20	44x1/6"	20				432132	Anfrage	432232	Anfrage
	25	52x1/6"	26				432133	Anfrage	432233	Anfrage
	32	58x1/6"	32				432134	Anfrage	432234	Anfrage
	40	65x1/6"	38				432135	Anfrage	432235	Anfrage
	50	78x1/6"	50				432136	Anfrage	432236	Anfrage
	65	95x1/6"	66				432137	Anfrage	432237	Anfrage
	80	110x1/4"	81				432138	Anfrage	432238	Anfrage
	100	130x1/4"	100				432139	Anfrage	432239	Anfrage
	125	160x1/4"	125				432141	Anfrage	432241	Anfrage
	150	190x1/4"	150				432142	Anfrage	432242	Anfrage
	200	240x1/4"	200				432144	Anfrage	432244	Anfrage
<b>C nach Wunsch</b> <b>C on demand</b>										

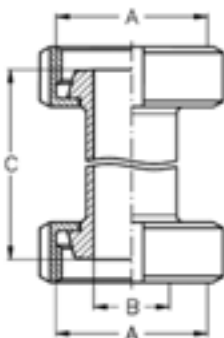
Rohrverschraubungen DIN 11851 + SMS							Art.No.	EUR	Art.No.	EUR
<b>Zwischenstück KK</b> <b>Intermediate piece KK</b> 	DN	A	B				AISI304		AISI316L-1.4404	
	10	28x1/8"	10				432730	Anfrage	432830	Anfrage
	15	34x1/8"	16				432731	Anfrage	432831	Anfrage
	20	44x1/6"	20				432732	Anfrage	432832	Anfrage
	25	52x1/6"	26				432733	Anfrage	432833	Anfrage
	32	58x1/6"	32				432734	Anfrage	432834	Anfrage
	40	65x1/6"	38				432735	Anfrage	432835	Anfrage
	50	78x1/6"	50				432736	Anfrage	432836	Anfrage
	65	95x1/6"	66				432737	Anfrage	432837	Anfrage
	80	110x1/4"	81				432738	Anfrage	432838	Anfrage
	100	130x1/4"	100				432739	Anfrage	432839	Anfrage
	125	160x1/4"	125				432741	Anfrage	432841	Anfrage
	150	190x1/4"	150				432742	Anfrage	432842	Anfrage
	200	240x1/4"	200				432744	Anfrage	432844	Anfrage
<b>C nach Wunsch</b> <b>C on demand</b>										

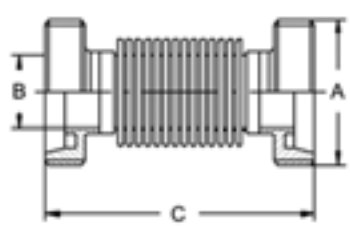
<b>Kompensator GG</b> <b>Compensator GG</b> 	DN	A	B	C			AISI304		AISI316L-1.4404	
	20	44x1/6"	19	213			436732	Anfrage	436832	Anfrage
	25	52x1/6"	25	229			436733	Anfrage	436833	Anfrage
	32	58x1/6"	31	229			436734	Anfrage	436834	Anfrage
	40	65x1/6"	37	234			436735	Anfrage	436835	Anfrage
	50	78x1/6"	49	251			436736	Anfrage	436836	Anfrage
	65	95x1/6"	66	280			436737	Anfrage	436837	Anfrage
	80	110x1/4"	81	280			436738	Anfrage	436838	Anfrage
	100	130x1/4"	100	290			436739	Anfrage	436839	Anfrage
	125	160x1/4"	125	362			436741	Anfrage	436841	Anfrage

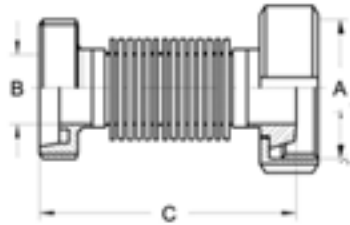
<b>Kompensator GK</b> <b>Compensator GK</b> 	DN	A	B	C			AISI304		AISI316L-1.4404	
	20	44x1/6"	19	207			436932	Anfrage	437032	Anfrage
	25	52x1/6"	25	222			436933	Anfrage	437033	Anfrage
	32	58x1/6"	31	222			436934	Anfrage	437034	Anfrage
	40	65x1/6"	37	227			436935	Anfrage	437035	Anfrage
	50	78x1/6"	49	244			436936	Anfrage	437036	Anfrage
	65	95x1/6"	66	272			436937	Anfrage	437037	Anfrage
	80	110x1/4"	81	272			436938	Anfrage	437038	Anfrage
	100	130x1/4"	100	280			436939	Anfrage	437039	Anfrage
	125	160x1/4"	125	350			436941	Anfrage	437041	Anfrage

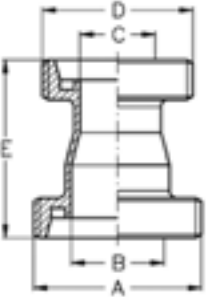

Rohrverschraubungen DIN 11851 + SMS							Art.No.	EUR	Art.No.	EUR
<b>Reduzierstück GG</b> <b>Reducer GG</b> 	DN	A	B	C	D	E	AISI304		AISI316L-1.4404	
	<b>32-25</b>	58x1/6"	32	26	52x1/6"	62	430767	<b>57,80</b>	430867	<b>108,50</b>
	<b>40-25</b>	65x1/6"	38	26	52x1/6"	73	430770	<b>61,90</b>	430870	<b>110,90</b>
	<b>40-32</b>	65x1/6"	38	32	58x1/6"	65	430771	<b>63,40</b>	430871	<b>111,80</b>
	<b>50-32</b>	78x1/6"	50	32	58x1/6"	88	430773	<b>70,20</b>	430873	<b>129,30</b>
	<b>50-40</b>	78x1/6"	50	38	65x1/6"	78	430774	<b>68,90</b>	430874	<b>121,80</b>
	<b>65-40</b>	95x1/6"	66	38	65x1/6"	93	430777	<b>88,80</b>	430877	<b>151,60</b>
	<b>65-50</b>	95x1/6"	66	50	78x1/6"	89	430778	<b>85,30</b>	430878	<b>156,70</b>
	<b>80-50</b>	110x1/4"	81	50	78x1/6"	116	430782	<b>115,30</b>	430882	<b>213,20</b>
	<b>80-65</b>	110x1/4"	81	66	95x1/6"	92	430783	<b>121,90</b>	430883	<b>215,40</b>
	<b>100-65</b>	130x1/4"	100	66	95x1/6"	131	430785	<b>162,40</b>	430885	<b>261,60</b>
	<b>100-80</b>	130x1/4"	100	81	110x1/4"	109	430786	<b>167,10</b>	430886	<b>279,90</b>

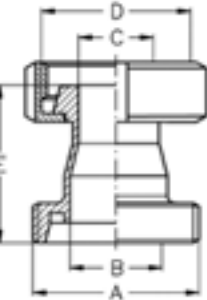
<b>Reduzierstück GK</b> <b>Reducer GK</b> 	DN	A	B	C	D	E	AISI304		AISI316L-1.4404	
	<b>32-25</b>	58x1/6"	32	26	52x1/6"	55	430167	<b>68,50</b>	430267	<b>74,70</b>
	<b>40-25</b>	65x1/6"	38	26	52x1/6"	66	430170	<b>71,90</b>	430270	<b>79,60</b>
	<b>40-32</b>	65x1/6"	38	32	58x1/6"	58	430171	<b>6,60</b>	430271	<b>81,80</b>
	<b>50-32</b>	78x1/6"	50	32	58x1/6"	81	430173	<b>81,60</b>	430273	<b>89,90</b>
	<b>50-40</b>	78x1/6"	50	38	65x1/6"	71	430174	<b>82,10</b>	430274	<b>92,10</b>
	<b>65-40</b>	95x1/6"	66	38	65x1/6"	102	430177	<b>100,40</b>	430277	<b>114,30</b>
	<b>65-50</b>	95x1/6"	66	50	78x1/6"	82	430178	<b>102,10</b>	430278	<b>146,80</b>
	<b>80-50</b>	110x1/4"	81	50	78x1/6"	109	430182	<b>130,50</b>	430282	<b>152,80</b>
	<b>80-65</b>	110x1/4"	81	66	95x1/6"	84	430183	<b>146,20</b>	430283	<b>166,60</b>
	<b>100-65</b>	130x1/4"	100	66	95x1/6"	123	430185	<b>187,60</b>	430285	<b>242,50</b>
	<b>100-80</b>	130x1/4"	100	81	110x1/4"	101	430186	<b>204,30</b>	430286	<b>264,80</b>

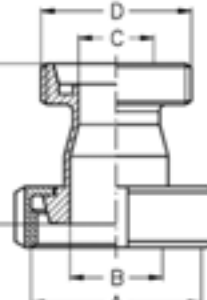
<b>Reduzierstück KG</b> <b>Reducer KG</b> 	DN	A	B	C	D	E	AISI304		AISI316L-1.4404	
	<b>32-25</b>	58x1/6"	32	26	52x1/6"	55	430367	<b>70,30</b>	430467	<b>76,70</b>
	<b>40-25</b>	65x1/6"	38	26	52x1/6"	66	430370	<b>75,30</b>	430470	<b>82,40</b>
	<b>40-32</b>	65x1/6"	38	32	58x1/6"	58	430371	<b>77,70</b>	430471	<b>85,20</b>
	<b>50-32</b>	78x1/6"	50	32	58x1/6"	81	430373	<b>88,60</b>	430473	<b>95,90</b>
	<b>50-40</b>	78x1/6"	50	38	65x1/6"	71	430374	<b>88,90</b>	430474	<b>98,40</b>
	<b>65-40</b>	95x1/6"	66	38	65x1/6"	101	430377	<b>112,90</b>	430477	<b>126,40</b>
	<b>65-50</b>	95x1/6"	66	50	78x1/6"	81	430378	<b>115,30</b>	430478	<b>128,40</b>
	<b>80-50</b>	110x1/4"	81	50	78x1/6"	109	430382	<b>156,30</b>	430482	<b>174,20</b>
	<b>80-65</b>	110x1/4"	81	66	95x1/6"	84	430383	<b>162,50</b>	430483	<b>179,80</b>
	<b>100-65</b>	130x1/4"	100	66	95x1/6"	121	430385	<b>226,60</b>	430485	<b>308,50</b>
	<b>100-80</b>	130x1/4"	100	81	110x1/4"	99	430386	<b>231,40</b>	430486	<b>302,40</b>

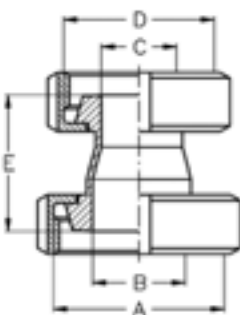
Rohrverschraubungen DIN 11851 + SMS							Art.No.	EUR	Art.No.	EUR
<b>Reduzierstück KK</b> <b>Reducer KK</b> 	DN	A	B	C	D	E	AISI304		AISI316L-1.4404	
	<b>32-25</b>	58x1/6"	32	26	52x1/6"	48	430567	<b>82,20</b>	430667	<b>86,80</b>
	<b>40-25</b>	65x1/6"	38	26	52x1/6"	59	430570	<b>86,60</b>	430670	<b>93,10</b>
	<b>40-32</b>	65x1/6"	38	32	58x1/6"	51	430571	<b>89,80</b>	430671	<b>97,40</b>
	<b>50-32</b>	78x1/6"	50	32	58x1/6"	74	430573	<b>98,70</b>	430673	<b>107,50</b>
	<b>50-40</b>	78x1/6"	50	38	65x1/6"	64	430574	<b>101,10</b>	430674	<b>110,80</b>
	<b>65-40</b>	95x1/6"	66	38	65x1/6"	94	430577	<b>127,60</b>	430677	<b>138,40</b>
	<b>65-50</b>	95x1/6"	66	50	78x1/6"	74	430578	<b>130,50</b>	430678	<b>142,50</b>
	<b>80-50</b>	110x1/4"	81	50	78x1/6"	101	430582	<b>172,90</b>	430682	<b>188,70</b>
	<b>80-65</b>	110x1/4"	81	66	95x1/6"	76	430583	<b>188,80</b>	430683	<b>202,30</b>
	<b>100-65</b>	130x1/4"	100	66	95x1/6"	113	430585	<b>251,30</b>	430685	<b>327,20</b>
	<b>100-80</b>	130x1/4"	100	81	110x1/4"	91	430586	<b>269,90</b>	430686	<b>351,60</b>

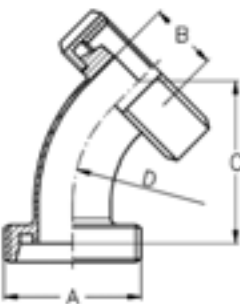
<b>Bogen 45° KG</b> <b>Bend 45° KG</b> 	DN	A	B	C	D	AISI304		AISI316L-1.4404		
	<b>10</b>	28x1/8"	10	38,5	26		431730	<b>54,80</b>	431830	<b>71,50</b>
	<b>15</b>	34x1/8"	16	44	35		431731	<b>Anfrage</b>	431831	<b>84,20</b>
	<b>20</b>	44x1/6"	20	48,5	40		431732	<b>66,70</b>	431832	<b>86,70</b>
	<b>25</b>	52x1/6"	26	59	50		431733	<b>67,80</b>	431833	<b>88,80</b>
	<b>32</b>	58x1/6"	32	62,5	55		431734	<b>69,10</b>	431834	<b>89,90</b>
	<b>40</b>	65x1/6"	38	66	60		431735	<b>73,40</b>	431835	<b>95,30</b>
	<b>50</b>	78x1/6"	50	74,5	70		431736	<b>86,80</b>	431836	<b>112,90</b>
	<b>65</b>	95x1/6"	66	83,5	80		431737	<b>120,80</b>	431837	<b>157,10</b>
	<b>80</b>	110x1/4"	81	90,5	90		431738	<b>186,60</b>	431838	<b>279,30</b>
	<b>100</b>	130x1/4"	100	102	100		431739	<b>271,30</b>	431839	<b>405,80</b>
	<b>125</b>	160x1/4"	125	170	187		431741	<b>Anfrage</b>	431841	<b>Anfrage</b>
	<b>150</b>	190x1/4"	150	202	225		431742	<b>Anfrage</b>	431842	<b>Anfrage</b>
	<b>200</b>	240x1/4"	200	-	300		431744	<b>Anfrage</b>	431844	<b>Anfrage</b>

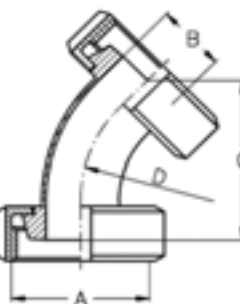
<b>Bogen 45° KK</b> <b>Bend 45° KK</b> 	DN	A	B	C	D	AISI304		AISI316L-1.4404		
	<b>10</b>	28x1/8"	10	38,5	26		432530	<b>62,20</b>	432630	<b>79,90</b>
	<b>15</b>	34x1/8"	16	44	35		432531	<b>71,90</b>	432631	<b>93,20</b>
	<b>20</b>	44x1/6"	20	48,5	40		432532	<b>85,70</b>	432632	<b>96,20</b>
	<b>25</b>	52x1/6"	26	59	50		432533	<b>87,30</b>	432633	<b>98,70</b>
	<b>32</b>	58x1/6"	32	62,5	55		432534	<b>88,90</b>	432634	<b>106,50</b>
	<b>40</b>	65x1/6"	38	66	60		432535	<b>92,90</b>	432635	<b>112,20</b>
	<b>50</b>	78x1/6"	50	74,5	70		432536	<b>102,30</b>	432636	<b>134,10</b>
	<b>65</b>	95x1/6"	66	83,5	80		432537	<b>144,90</b>	432637	<b>188,50</b>
	<b>80</b>	110x1/4"	81	90,5	90		432538	<b>221,80</b>	432638	<b>328,80</b>
	<b>100</b>	130x1/4"	100	102	100		432539	<b>328,30</b>	432639	<b>491,50</b>
	<b>125</b>	160x1/4"	125	170	187		432541	<b>Anfrage</b>	432641	<b>Anfrage</b>
	<b>150</b>	190x1/4"	150	202	225		432542	<b>Anfrage</b>	432642	<b>Anfrage</b>
	<b>200</b>	240x1/4"	200	-	300		432544	<b>Anfrage</b>	432644	<b>Anfrage</b>

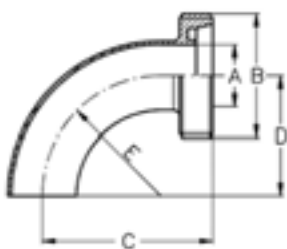
Rohrverschraubungen DIN 11851 + SMS							Art.No.	EUR	Art.No.	EUR
<b>Bogen 90° GS</b> <b>Bend 90° GS</b> 	DN	A	B	C	D	E	AISI304		AISI316L-1.4404	
	10	9	28x1/8"	43	26	26	431130	<b>32,90</b>	431230	<b>39,10</b>
	15	15	34x1/8"	52	35	35	431131	<b>34,60</b>	431231	<b>41,20</b>
	20	19	44x1/6"	59	40	40	431132	<b>40,40</b>	431232	<b>47,30</b>
	25	25	52x1/6"	72	50	50	431133	<b>44,50</b>	431233	<b>51,40</b>
	32	31	58x1/6"	77	55	55	431134	<b>48,20</b>	431234	<b>55,80</b>
	40	37	65x1/6"	82	60	60	431135	<b>50,90</b>	431235	<b>58,90</b>
	50	49	78x1/6"	93	70	70	431136	<b>55,50</b>	431236	<b>64,70</b>
	65	66	95x1/6"	105	80	80	431137	<b>76,20</b>	431237	<b>87,80</b>
	80	81	110x1/4"	115	90	90	431138	<b>105,30</b>	431238	<b>124,20</b>
	100	100	130x1/4"	130	100	100	431139	<b>138,20</b>	431239	<b>166,80</b>
	125	125	160x1/4"	223	187	187	431141	<b>Anfrage</b>	431241	<b>Anfrage</b>
	150	150	190x1/4"	265	225	225	431142	<b>Anfrage</b>	431242	<b>Anfrage</b>
200	200	240x1/4"	-	300	300	431144	<b>Anfrage</b>	431244	<b>Anfrage</b>	

B3

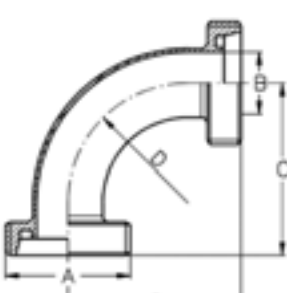
<b>Bogen 90° GG</b> <b>Bend 90° GG</b> 	DN	A	B	C	D	AISI304		AISI316L-1.4404		
	10	28x1/8"	10	43	26		431330	<b>48,20</b>	431430	<b>62,30</b>
	15	34x1/8"	16	52	35		431331	<b>56,60</b>	431431	<b>73,60</b>
	20	44x1/6"	20	59	40		431332	<b>62,30</b>	431432	<b>81,90</b>
	25	52x1/6"	26	72	50		431333	<b>63,70</b>	431433	<b>84,30</b>
	32	58x1/6"	32	77	55		431334	<b>66,80</b>	431434	<b>85,40</b>
	40	65x1/6"	38	82	60		431335	<b>67,80</b>	431435	<b>86,70</b>
	50	78x1/6"	50	93	70		431336	<b>72,30</b>	431436	<b>93,90</b>
	65	95x1/6"	66	105	80		431337	<b>97,50</b>	431437	<b>126,80</b>
	80	110x1/4"	81	115	90		431338	<b>151,20</b>	431438	<b>226,30</b>
	100	130x1/4"	100	130	100		431339	<b>213,30</b>	431439	<b>319,80</b>
	125	160x1/4"	125	223	187		431341	<b>Anfrage</b>	431441	<b>Anfrage</b>
	150	190x1/4"	150	265	225		431342	<b>Anfrage</b>	431442	<b>Anfrage</b>
200	240x1/4"	200	-	300		431344	<b>Anfrage</b>	431444	<b>Anfrage</b>	

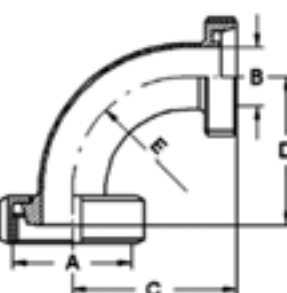
<b>Bogen 90° KG</b> <b>Bend 90° KG</b> 	DN	A	B	C	D	E	AISI304		AISI316L-1.4404	
	10	28x1/8"	10	43	39	26	431530	<b>54,90</b>	431630	<b>71,90</b>
	15	34x1/8"	16	52	48	35	431531	<b>64,60</b>	431631	<b>83,90</b>
	20	44x1/6"	20	59	53	40	431532	<b>66,70</b>	431632	<b>86,60</b>
	25	52x1/6"	26	72	65	50	431533	<b>67,80</b>	431633	<b>88,70</b>
	32	58x1/6"	32	77	70	55	431534	<b>69,90</b>	431634	<b>89,80</b>
	40	65x1/6"	38	82	75	60	431535	<b>72,40</b>	431635	<b>95,10</b>
	50	78x1/6"	50	93	86	70	431536	<b>86,80</b>	431636	<b>113,20</b>
	65	95x1/6"	66	105	97	80	431537	<b>120,60</b>	431637	<b>155,90</b>
	80	110x1/4"	81	115	107	90	431538	<b>186,40</b>	431638	<b>278,80</b>
	100	130x1/4"	100	130	120	100	431539	<b>271,30</b>	431639	<b>405,50</b>
	125	160x1/4"	125	223	211	187	431541	<b>Anfrage</b>	431641	<b>Anfrage</b>
	150	190x1/4"	150	265	252	225	431542	<b>Anfrage</b>	431642	<b>Anfrage</b>
200	240x1/4"	200	-	-	300	431544	<b>Anfrage</b>	431644	<b>Anfrage</b>	

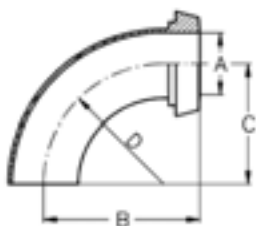
Rohrverschraubungen DIN 11851 + SMS							Art.No.	EUR	Art.No.	EUR
<b>Bogen 90° KS</b> <b>Bend 90° KS</b> 	DN	A	B	C	D		AISI304		AISI316L-1.4404	
	10	9	39	26	26		431930	29,50	432030	31,50
	15	15	48	35	35		431931	30,70	432031	33,40
	20	19	53	40	40		431932	33,40	432032	38,20
	25	25	65	50	50		431933	40,10	432033	48,10
	32	31	70	55	55		431934	44,70	432034	51,40
	40	37	75	60	60		431935	46,90	432035	53,90
	50	49	86	70	70		431936	50,80	432036	58,80
	65	66	97	80	80		431937	69,20	432037	90,60
	80	81	107	90	90		431938	94,30	432038	112,10
	100	100	120	100	100		431939	138,20	432039	153,90
	125	125	211	187	187		431941	Anfrage	432041	Anfrage
	150	150	252	225	225		431942	Anfrage	432042	Anfrage
200	200	-	300	300		431944	Anfrage	432044	Anfrage	

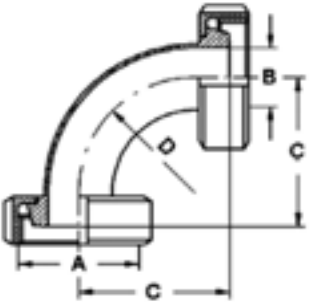
<b>Bogen 90° KK</b> <b>Bend 90° KK</b> 	DN	A	B	C	D		AISI304		AISI316L-1.4404	
	10	28x1/8"	10	39	26		432330	60,20	432430	78,50
	15	34x1/8"	16	48	35		432331	72,30	432431	93,20
	20	44x1/6"	20	53	40		432332	86,10	432432	95,60
	25	52x1/6"	26	65	50		432333	87,70	432433	98,60
	32	58x1/6"	32	70	55		432334	89,90	432434	106,50
	40	65x1/6"	38	75	60		432335	93,40	432435	113,10
	50	78x1/6"	50	86	70		432336	102,10	432436	133,80
	65	95x1/6"	66	97	80		432337	144,80	432437	188,50
	80	110x1/4"	81	107	90		432338	221,60	432438	329,40
	100	130x1/4"	100	120	100		432339	328,40	432439	491,50
	125	160x1/4"	125	211	187		432341	Anfrage	432441	Anfrage
	150	190x1/4"	150	252	225		432342	Anfrage	432442	Anfrage
200	240x1/4"	200	-	300		432344	Anfrage	432444	Anfrage	

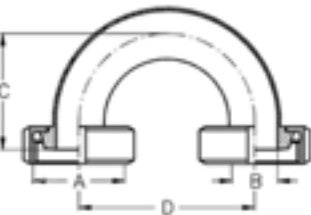
<b>Bogen 180° KK</b> <b>Bend 180° KK</b> 	DN	A	B	C	D		AISI304		AISI316L-1.4404	
	10	28x1/8"	10	39	52		433530	Anfrage	433630	Anfrage
	15	34x1/8"	16	48	70		433531	Anfrage	433631	Anfrage
	20	44x1/6"	20	53	80		433532	Anfrage	433632	Anfrage
	25	52x1/6"	26	65	100		433533	Anfrage	433633	Anfrage
	32	58x1/6"	32	70	110		433534	Anfrage	433634	Anfrage
	40	65x1/6"	38	75	120		433535	Anfrage	433635	Anfrage
	50	78x1/6"	50	86	140		433536	Anfrage	433636	Anfrage
	65	95x1/6"	66	97	160		433537	Anfrage	433637	Anfrage
	80	110x1/4"	81	107	180		433538	Anfrage	433638	Anfrage
	100	130x1/4"	100	120	200		433539	Anfrage	433639	Anfrage
	125	160x1/4"	125	221,5	375		433541	Anfrage	433641	Anfrage
	150	190x1/4"	150	262	450		433542	Anfrage	433642	Anfrage
200	240x1/4"	200	-	600		433544	Anfrage	433644	Anfrage	

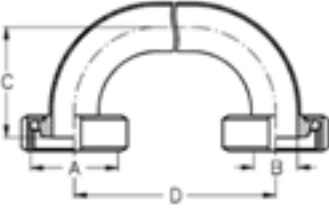
Rohrverschraubungen DIN 11851 + SMS							Art.No.	EUR	Art.No.	EUR
<b>Umlenkbogen 180° KK</b> <b>Reversible bend 180° KK</b> 	DN	A	B	C			AISI304		AISI316L-1.4404	
	10	28x1/8"	10	39			433730	Anfrage	433830	Anfrage
	15	34x1/8"	16	48			433731	Anfrage	433831	Anfrage
	20	44x1/6"	20	53			433732	Anfrage	433832	Anfrage
	25	52x1/6"	26	65			433733	Anfrage	433833	Anfrage
	32	58x1/6"	32	70			433734	Anfrage	433834	Anfrage
	40	65x1/6"	38	75			433735	Anfrage	433835	Anfrage
	50	78x1/6"	50	86			433736	Anfrage	433836	Anfrage
	65	95x1/6"	66	97			433737	Anfrage	433837	Anfrage
	80	110x1/4"	81	107			433738	Anfrage	433838	Anfrage
	100	130x1/4"	100	120			433739	Anfrage	433839	Anfrage
	125	160x1/4"	125	221,5			433741	Anfrage	433841	Anfrage
	150	190x1/4"	150	262			433742	Anfrage	433842	Anfrage
	200	240x1/4"	200	-			433744	Anfrage	433844	Anfrage
<b>D nach Wunsch</b> <b>D on demand</b>										

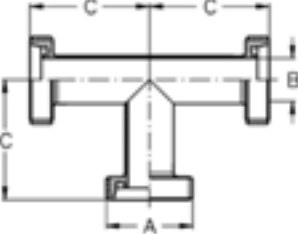
<b>T-Stück GGG</b> <b>T-piece GGG</b> 	DN	A	B	C			AISI304		AISI316L-1.4404	
	10	28x1/8"	10	43			434130	<b>82,80</b>	434230	<b>120,20</b>
	15	34x1/8"	16	52			434131	<b>96,40</b>	434231	<b>133,90</b>
	20	44x1/6"	20	59			434132	<b>98,80</b>	434232	<b>136,80</b>
	25	52x1/6"	26	72			434133	<b>100,50</b>	434233	<b>114,20</b>
	32	58x1/6"	32	77			434134	<b>101,70</b>	434234	<b>119,30</b>
	40	65x1/6"	38	82			434135	<b>103,10</b>	434235	<b>125,80</b>
	50	78x1/6"	50	93			434136	<b>117,40</b>	434236	<b>144,90</b>
	65	95x1/6"	66	105			434137	<b>122,80</b>	434237	<b>192,90</b>
	80	110x1/4"	81	115			434138	<b>207,70</b>	434238	<b>308,10</b>
	100	130x1/4"	100	130			434139	<b>296,80</b>	434239	<b>424,30</b>
	125	160x1/4"	125	223			434141	Anfrage	434241	Anfrage
	150	190x1/4"	150	265			434142	Anfrage	434242	Anfrage
	200	240x1/4"	200	-			434144	Anfrage	434244	Anfrage

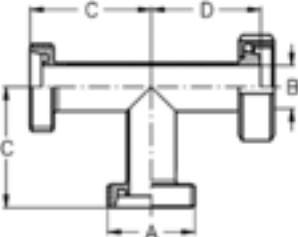
<b>T-Stück GKG</b> <b>T-piece GKG</b> 	DN	A	B	C	D		AISI304		AISI316L-1.4404	
	10	28x1/8"	10	43	39		434330	<b>85,40</b>	434430	<b>122,50</b>
	15	34x1/8"	16	52	48		434331	<b>103,90</b>	434431	<b>145,90</b>
	20	44x1/6"	20	59	53		434332	<b>106,50</b>	434432	<b>147,70</b>
	25	52x1/6"	26	72	65		434333	<b>109,60</b>	434433	<b>122,90</b>
	32	58x1/6"	32	77	70		434334	<b>111,70</b>	434434	<b>134,80</b>
	40	65x1/6"	38	82	75		434335	<b>116,90</b>	434435	<b>141,90</b>
	50	78x1/6"	50	93	86		434336	<b>134,50</b>	434436	<b>164,60</b>
	65	95x1/6"	66	105	97		434337	<b>181,20</b>	434437	<b>226,50</b>
	80	110x1/4"	81	115	107		434338	<b>246,30</b>	434438	<b>363,90</b>
	100	130x1/4"	100	130	120		434339	<b>254,90</b>	434439	<b>510,90</b>
	125	160x1/4"	125	223	211		434341	Anfrage	434441	Anfrage
	150	190x1/4"	150	265	252		434342	Anfrage	434442	Anfrage
	200	240x1/4"	200	-	-		434344	Anfrage	434444	Anfrage

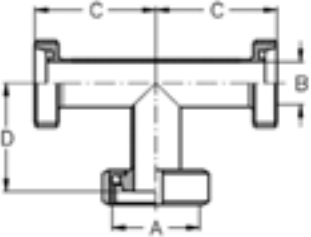
Rohrverschraubungen DIN 11851 + SMS							Art.No.	EUR	Art.No.	EUR
<b>T-Stück GGK</b> <b>T-piece GGK</b>  	DN	A	B	C	D		AISI304		AISI316L-1.4404	
	10	28x1/8"	9	43	39		434530	90,70	434630	130,40
	15	34x1/8"	15	52	48		434531	105,40	434631	150,60
	20	44x1/6"	19	59	53		434532	107,50	434632	153,80
	25	52x1/6"	25	72	65		434533	19,60	434633	128,20
	32	58x1/6"	31	77	70		434534	113,80	434634	138,30
	40	65x1/6"	37	82	75		434535	118,20	434635	151,10
	50	78x1/6"	49	93	86		434536	139,40	434636	177,60
	65	95x1/6"	66	105	97		434537	193,20	434637	241,80
	80	110x1/4"	81	115	107		434538	271,50	434638	381,40
	100	130x1/4"	100	130	120		434539	390,80	434639	556,10
	125	160x1/4"	125	233,5	221,5		434541	Anfrage	434641	Anfrage
	150	190x1/4"	150	275	262		434542	Anfrage	434642	Anfrage
200	240x1/4"	200	-	-		434544	Anfrage	434644	Anfrage	

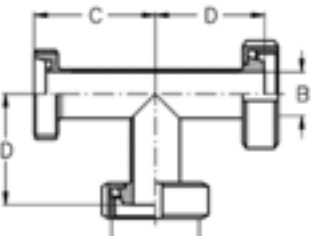
<b>T-Stück GKK</b> <b>T-piece GKK</b>  	DN	A	B	C	D		AISI304		AISI316L-1.4404	
	10	28x1/8"	9	43	39		434730	103,80	434830	142,90
	15	34x1/8"	15	52	48		434731	122,90	434831	172,40
	20	44x1/6"	19	59	53		434732	124,80	434832	161,50
	25	52x1/6"	25	72	65		434733	127,20	434833	150,40
	32	58x1/6"	31	77	70		434734	133,90	434834	166,50
	40	65x1/6"	37	82	75		434735	144,80	434835	175,80
	50	78x1/6"	49	93	86		434736	170,90	434836	208,60
	65	95x1/6"	66	105	97		434737	241,80	434837	287,50
	80	110x1/4"	81	115	107		434738	340,70	434838	461,70
	100	130x1/4"	100	130	120		434739	491,50	434839	672,90
	125	160x1/4"	125	233,5	221,5		434741	Anfrage	434841	Anfrage
	150	190x1/4"	150	275	262		434742	Anfrage	434842	Anfrage
200	240x1/4"	200	-	-		434744	Anfrage	434844	Anfrage	

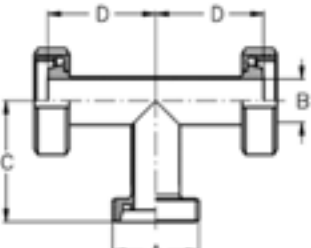
<b>T-Stück KKG</b> <b>T-piece KKG</b>  	DN	A	B	C	D		AISI304		AISI316L-1.4404	
	10	28x1/8"	9	43	39		435130	103,80	435230	142,90
	15	34x1/8"	15	52	48		435131	122,90	435231	172,40
	20	44x1/6"	19	59	53		435132	124,80	435232	161,50
	25	52x1/6"	25	72	65		435133	127,20	435233	150,40
	32	58x1/6"	31	77	70		435134	133,90	435234	166,60
	40	65x1/6"	37	82	75		435135	144,70	435235	175,80
	50	78x1/6"	49	93	86		435136	170,90	435236	208,60
	65	95x1/6"	66	105	97		435137	241,80	435237	287,50
	80	110x1/4"	81	115	107		435138	340,70	435238	461,70
	100	130x1/4"	100	130	120		435139	491,50	435239	672,90
	125	160x1/4"	125	233,5	221,5		435141	Anfrage	435241	Anfrage
	150	190x1/4"	150	275	262		435142	Anfrage	435242	Anfrage
200	240x1/4"	200	-	-		435144	Anfrage	435244	Anfrage	

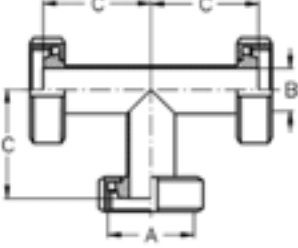
Rohrverschraubungen DIN 11851 + SMS							Art.No.	EUR	Art.No.	EUR
<b>T-Stück KKK</b> <b>T-piece KKK</b> 	DN	A	B	C			AISI304		AISI316L-1.4404	
	10	28x1/8"	10	39			434930	97,60	435030	150,60
	15	34x1/8"	16	48			434931	118,40	435031	173,20
	20	44x1/6"	20	53			434932	120,80	435032	164,80
	25	52x1/6"	26	65			434933	122,60	435033	154,70
	32	58x1/6"	32	70			434934	134,90	435034	169,80
	40	65x1/6"	38	75			434935	140,30	435035	175,70
	50	78x1/6"	50	86			434936	164,70	435036	215,20
	65	95x1/6"	66	97			434937	226,40	435037	296,70
	80	110x1/4"	81	107			434938	310,70	435038	469,50
	100	130x1/4"	100	120			434939	463,90	435039	693,80
	125	160x1/4"	125	211			434941	Anfrage	435041	Anfrage
	150	190x1/4"	150	252			434942	Anfrage	435042	Anfrage
	200	240x1/4"	200	-			434944	Anfrage	435044	Anfrage

B3

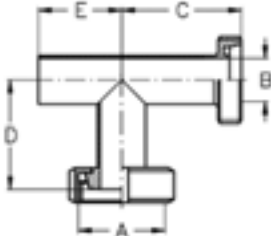
<b>T-Stück SGK</b> <b>T-piece SGK</b> 	DN	A	B	C	D	E	AISI304		AISI316L-1.4404	
	10	28x1/8"	9	43	39	26	433930	67,70	434030	101,70
	15	34x1/8"	15	52	48	35	433931	83,20	434031	120,90
	20	44x1/6"	19	59	53	40	433932	84,10	434032	125,10
	25	52x1/6"	25	72	65	50	433933	85,60	434033	98,70
	32	58x1/6"	31	77	70	55	433934	87,30	434034	106,90
	40	65x1/6"	37	82	75	60	433935	93,10	434035	112,80
	50	78x1/6"	49	93	86	70	433936	109,60	434036	130,60
	65	95x1/6"	66	105	97	80	433937	144,70	434037	175,80
	80	110x1/4"	81	115	107	90	433938	188,80	434038	296,70
	100	130x1/4"	100	130	120	100	433939	194,50	434039	409,60
	125	160x1/4"	125	223	211	187	433941	Anfrage	434041	Anfrage
	150	190x1/4"	150	265	252	225	433942	Anfrage	434042	Anfrage
	200	240x1/4"	200	-	-	300	433944	Anfrage	434044	Anfrage

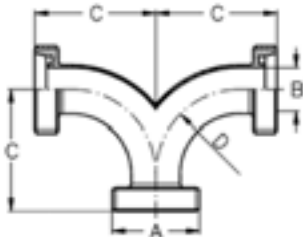
<b>Y-Bogen GGG</b> <b>Y-bend GGG</b> 	DN	A	B	C	D	AISI304		AISI316L-1.4404		
	25	52x1/6"	26	72	50		435333	146,80	435433	190,80
	32	58x1/6"	32	77	55		435334	164,70	435434	206,40
	40	65x1/6"	38	82	60		435335	171,20	435435	226,50
	50	78x1/6"	50	93	70		435336	196,30	435436	267,80
	65	95x1/6"	66	105	80		435337	261,20	435437	344,10
	80	110x1/4"	81	115	90		435338	343,90	435438	460,60
	100	130x1/4"	100	130	100		435339	471,60	435439	612,40
	125	160x1/4"	125	223	187		435341	Anfrage	435441	Anfrage
150	190x1/4"	150	265	225		435342	Anfrage	435442	Anfrage	

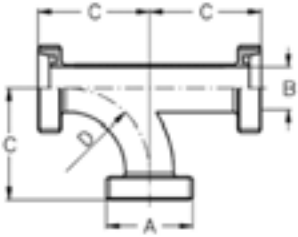
Rohrverschraubungen DIN 11851 + SMS							Art.No.	EUR	Art.No.	EUR
<b>T-Bogen GGG</b> <b>T-bend GGG</b> 	DN	A	B	C	D		AISI304		AISI316L-1.4404	
	25	52x1/6"	26	72	50		435533	142,80	435633	185,40
	32	58x1/6"	32	77	55		435534	160,90	435634	196,20
	40	65x1/6"	38	82	60		435535	165,60	435635	217,30
	50	78x1/6"	50	93	70		435536	180,10	435636	241,70
	65	95x1/6"	66	105	80		435537	232,60	435637	303,40
	80	110x1/4"	81	115	90		435538	324,10	435638	449,60
	100	130x1/4"	100	130	100		435539	444,40	435639	592,30
	125	160x1/4"	125	223,5	187		435541	Anfrage	435641	Anfrage
	150	190x1/4"	150	265	225		435542	Anfrage	435642	Anfrage

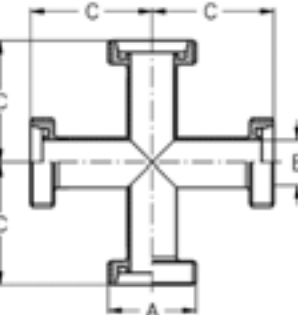
<b>Kreuzstück GGGG</b> <b>Cross piece GGGG</b> 	DN	A	B	C			AISI304		AISI316L-1.4404		
	10	28x1/8"	9	43				435730	Anfrage	435830	Anfrage
	15	34x1/8"	15	52				435731	Anfrage	435831	Anfrage
	20	44x1/6"	19	59				435732	Anfrage	435832	Anfrage
	25	52x1/6"	25	72				435733	Anfrage	435833	Anfrage
	32	58x1/6"	31	77				435734	Anfrage	435834	Anfrage
	40	65x1/6"	37	82				435735	Anfrage	435835	Anfrage
	50	78x1/6"	49	93				435736	Anfrage	435836	Anfrage
	65	95x1/6"	66	105				435737	Anfrage	435837	Anfrage
	80	110x1/4"	81	115				435738	Anfrage	435838	Anfrage
	100	130x1/4"	100	130				435739	Anfrage	435839	Anfrage
	125	160x1/4"	125	233,5				435741	Anfrage	435841	Anfrage
	150	190x1/4"	150	275				435742	Anfrage	435842	Anfrage
	200	240x1/4"	200	-				435744	Anfrage	435844	Anfrage

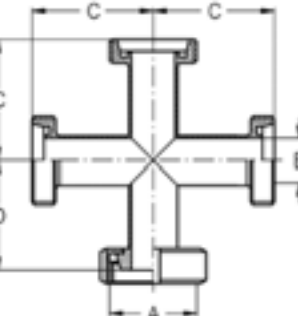
<b>Kreuzstück GGGK</b> <b>Cross piece GGGK</b> 	DN	A	B	C	D		AISI304		AISI316L-1.4404		
	10	28x1/8"	9	43	39			435930	Anfrage	436030	Anfrage
	15	34x1/8"	15	52	48			435931	Anfrage	436031	Anfrage
	20	44x1/6"	19	59	53			435932	Anfrage	436032	Anfrage
	25	52x1/6"	25	72	65			435933	Anfrage	436033	Anfrage
	32	58x1/6"	31	77	70			435934	Anfrage	436034	Anfrage
	40	65x1/6"	37	82	75			435935	Anfrage	436035	Anfrage
	50	78x1/6"	49	93	86			435936	Anfrage	436036	Anfrage
	65	95x1/6"	66	105	97			435937	Anfrage	436037	Anfrage
	80	110x1/4"	81	115	107			435938	Anfrage	436038	Anfrage
	100	130x1/4"	100	130	120			435939	Anfrage	436039	Anfrage
	125	160x1/4"	125	233,5	221,5			435941	Anfrage	436041	Anfrage
	150	190x1/4"	150	275	262			435942	Anfrage	436042	Anfrage
	200	240x1/4"	200	-	-			435944	Anfrage	436044	Anfrage

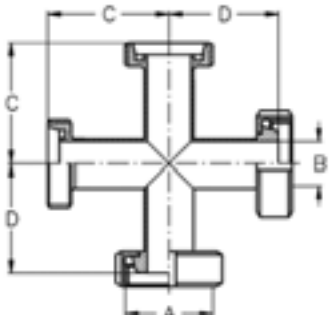

Rohrverschraubungen DIN 11851 + SMS							Art.No.	EUR	Art.No.	EUR
<b>Kreuzstück GGKK</b> Cross piece GGKK 	DN	A	B	C	D		AISI304		AISI316L-1.4404	
	10	28x1/8"	9	43	39		436130	Anfrage	436230	Anfrage
	15	34x1/8"	15	52	48		436131	Anfrage	436231	Anfrage
	20	44x1/6"	19	59	53		436132	Anfrage	436232	Anfrage
	25	52x1/6"	25	72	65		436133	Anfrage	436233	Anfrage
	32	58x1/6"	31	77	70		436134	Anfrage	436234	Anfrage
	40	65x1/6"	37	82	75		436135	Anfrage	436235	Anfrage
	50	78x1/6"	49	93	86		436136	Anfrage	436236	Anfrage
	65	95x1/6"	66	105	97		436137	Anfrage	436237	Anfrage
	80	110x1/4"	81	115	107		436138	Anfrage	436238	Anfrage
	100	130x1/4"	100	130	120		436139	Anfrage	436239	Anfrage
	125	160x1/4"	125	233,5	221,5		436141	Anfrage	436241	Anfrage
	150	190x1/4"	150	275	262		436142	Anfrage	436242	Anfrage
	200	240x1/4"	200	-	-		436144	Anfrage	436244	Anfrage

B3

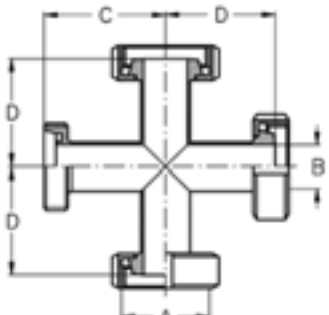
<b>Kreuzstück GKKK</b> Cross piece GKKK 	DN	A	B	C	D		AISI304		AISI316L-1.4404	
	10	28x1/8"	9	43	39		436530	Anfrage	436630	Anfrage
	15	34x1/8"	15	52	48		436531	Anfrage	436631	Anfrage
	20	44x1/6"	19	59	53		436532	Anfrage	436632	Anfrage
	25	52x1/6"	25	72	65		436533	Anfrage	436633	Anfrage
	32	58x1/6"	31	77	70		436534	Anfrage	436634	Anfrage
	40	65x1/6"	37	82	75		436535	Anfrage	436635	Anfrage
	50	78x1/6"	49	93	86		436536	Anfrage	436636	Anfrage
	65	95x1/6"	66	105	97		436537	Anfrage	436637	Anfrage
	80	110x1/4"	81	115	107		436538	Anfrage	436638	Anfrage
	100	130x1/4"	100	130	120		436539	Anfrage	436639	Anfrage
	125	160x1/4"	125	233,5	221,5		436541	Anfrage	436641	Anfrage
	150	190x1/4"	150	275	262		436542	Anfrage	436642	Anfrage
	200	240x1/4"	200	-	-		436544	Anfrage	436644	Anfrage

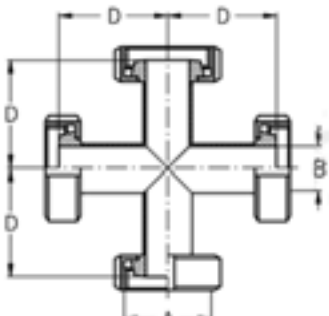
<b>Kreuzstück KKKK</b> Cross piece KKKK 	DN	A	B	D			AISI304		AISI316L-1.4404	
	10	28x1/8"	9	39			436330	Anfrage	436430	Anfrage
	15	34x1/8"	15	48			436331	Anfrage	436431	Anfrage
	20	44x1/6"	19	53			436332	Anfrage	436432	Anfrage
	25	52x1/6"	25	65			436333	Anfrage	436433	Anfrage
	32	58x1/6"	31	70			436334	Anfrage	436434	Anfrage
	40	65x1/6"	37	75			436335	Anfrage	436435	Anfrage
	50	78x1/6"	49	86			436336	Anfrage	436436	Anfrage
	65	95x1/6"	66	97			436337	Anfrage	436437	Anfrage
	80	110x1/4"	81	107			436338	Anfrage	436438	Anfrage
	100	130x1/4"	100	120			436339	Anfrage	436439	Anfrage
	125	160x1/4"	125	221,5			436341	Anfrage	436441	Anfrage
	150	190x1/4"	150	262			436342	Anfrage	436442	Anfrage
	200	240x1/4"	200	-			436344	Anfrage	436444	Anfrage

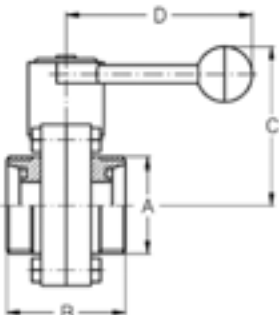
Rohrverschraubungen DIN 11851 + SMS							Art.No.	EUR	Art.No.	EUR
<b>Scheibenventil GG</b> Butterfly valve GG 	DN	A	B	C	D		AISI304-VMQ		AISI316L-VMQ	
	10	28x1/8"	78	79	105		440330	Anfrage	440430	Anfrage
	15	34x1/8"	78	79	105		440331	Anfrage	440431	Anfrage
	20	44x1/6"	78	79	105		440332	Anfrage	440432	Anfrage
	25	52x1/6"	64	89	107		440333	165,70	440433	215,20
	32	58x1/6"	64	91	107		440334	171,40	440434	222,90
	40	65x1/6"	72	94	137		440335	176,60	440435	227,40
	50	78x1/6"	72	100	137		440336	190,80	440436	242,90
	65	95x1/6"	76	109	137		440337	227,40	440437	277,70
	3"	104x1/6"	90	124	165		440307	326,40	440407	430,70
	80	110x1/4"	100	124	167		440338	326,50	440438	430,40
	100	130x1/4"	104	135	167		440339	401,60	440439	515,80
	125	160x1/4"	112	162	248		440341	Anfrage	440441	Anfrage
	150	190x1/4"	124	177	248		440342	Anfrage	440442	Anfrage
<b>Antriebe, Dichtungen etc. siehe Armaturen und Zubehör.</b> <b>Actuators, gaskets etc. see fittings and accessories.</b> <b>DN10 - DN20 nur mit Kunststoffhandgriff.</b> <b>DN10 - DN20 only with plastic handle.</b>										

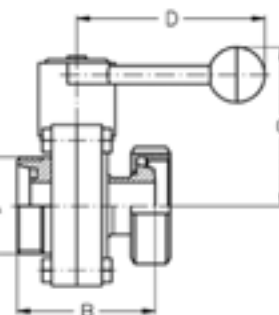
<b>Scheibenventil GK</b> Butterfly valve GK 	DN	A	B	C	D		AISI304-VMQ		AISI316L-VMQ	
	25	52x1/6"	74	89	107		440533	190,80	440633	248,30
	32	58x1/6"	78	91	107		440534	204,20	440634	262,50
	40	65x1/6"	87	94	137		440535	206,50	440635	267,70
	50	78x1/6"	89	100	137		440536	224,30	440636	292,50
	65	95x1/6"	95	109	137		440537	282,60	440637	368,90
	3"	104x1/6"	107	124	165		440507	394,50	440607	511,10
	80	110x1/4"	117	124	167		440538	395,90	440638	511,20
	100	130x1/4"	128	135	167		440539	501,20	440639	647,70
	125	160x1/4"	146	162	248		440541	Anfrage	440641	Anfrage
	150	190x1/4"	161	177	248		440542	Anfrage	440642	Anfrage
<b>Antriebe, Dichtungen etc. siehe Armaturen und Zubehör.</b> <b>Actuators, gaskets etc. see fittings and accessories.</b>										

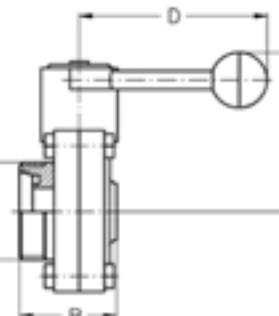
<b>Scheibenventil GS</b> Butterfly valve GS 	DN	A	B	C	D		AISI304-VMQ		AISI316L-VMQ	
	25	52x1/6"	52	89	107		440733	160,10	440833	205,90
	32	58x1/6"	53	91	107		440734	164,80	440834	213,10
	40	65x1/6"	61	94	137		440735	167,50	440835	218,20
	50	78x1/6"	61	100	137		440736	181,20	440836	236,30
	65	95x1/6"	63	109	137		440737	224,30	440837	286,90
	80	110x1/4"	80	124	167		440738	324,80	440838	519,60
	100	130x1/4"	84	135	167		440739	388,90	440839	500,90
	125	160x1/4"	112	162	248		440741	Anfrage	440841	Anfrage
	150	190x1/4"	124	177	248		440742	Anfrage	440842	Anfrage
<b>Antriebe, Dichtungen etc. siehe Armaturen und Zubehör.</b> <b>Actuators, gaskets etc. see fittings and accessories.</b>										

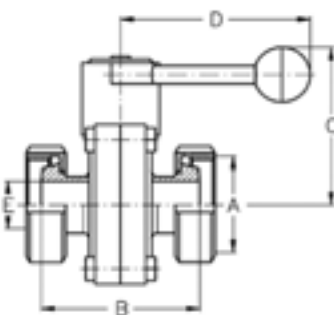
Rohrverschraubungen DIN 11851 + SMS							Art.No.	EUR	Art.No.	EUR
<b>Scheibenventil KK</b> 	DN	A	B	C	D	E	AISI304-VMQ		AISI316L-VMQ	
	10	28x1/8"	74	79	105	10	440930	Anfrage	441030	Anfrage
	15	34x1/8"	74	79	105	16	440931	Anfrage	441031	Anfrage
	20	44x1/6"	76	79	105	20	440932	Anfrage	441032	Anfrage
	25	52x1/6"	84	90	107	26	440933	219,80	441033	297,90
	32	58x1/6"	92	92	107	32	440934	235,20	441034	305,40
	40	65x1/6"	102	94	137	38	440935	241,60	441035	313,90
	50	78x1/6"	106	101	137	50	440936	262,30	441036	339,40
	65	95x1/6"	114	110	137	66	440937	343,90	441037	449,20
	3"	104x1/6"	124	124	165	72,1	440907	538,50	441007	643,20
	80	110x1/4"	134	123	167	81	440938	592,40	441038	643,20
	100	130x1/4"	152	134	167	100	440939	612,50	441039	790,70
	125	160x1/4"	180	168	248	125	440941	Anfrage	441041	Anfrage
	150	190x1/4"	198	183	248	150	440942	Anfrage	441042	Anfrage
<b>Antriebe, Dichtungen etc. siehe Armaturen und Zubehör.</b> <b>Actuators, gaskets etc. see fittings and accessories.</b> <b>DN10 - DN20 nur mit Kunststoffhandgriff.</b> <b>DN10 - DN20 only with plastic handle.</b>										

B3

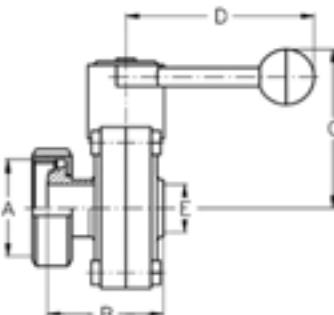
<b>Scheibenventil KS</b> <b>Butterfly valve KS</b> 	DN	A	B	C	D	E	AISI304-VMQ		AISI316L-VMQ	
	25	52x1/6"	62	89	107	26	441133	185,90	441233	241,60
	32	58x1/6"	67	91	107	32	441134	197,80	441234	255,90
	40	65x1/6"	76	94	137	38	441135	201,70	441235	262,40
	50	78x1/6"	78	100	137	50	441136	216,40	441236	279,80
	65	95x1/6"	82	109	137	66	441137	282,20	441237	364,90
	3"	104x1/6"	92	124	165	72,1	441107	394,70	441207	505,70
	80	110x1/4"	97	124	167	81	441138	394,50	441238	505,60
	100	130x1/4"	108	135	167	100	441139	490,90	441239	631,80
	125	160x1/4"	146	162	248	125	441141	Anfrage	441241	Anfrage
	150	190x1/4"	161	177	248	150	441142	Anfrage	441242	Anfrage
<b>Antriebe, Dichtungen etc. siehe Armaturen und Zubehör.</b> <b>Actuators, gaskets etc. see fittings and accessories.</b>										

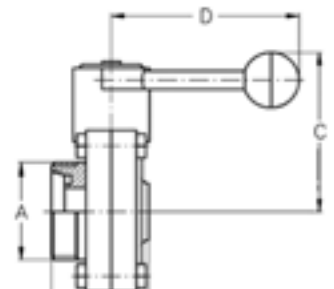
<b>Scheibenventil Zoll, GS</b> <b>Butterfly valve inch, GS</b> 	DN	A	B	C	D		AISI304-VMQ		AISI316L-VMQ	
	1"	52x1/6"	51	89	102		441303	160,90	441403	208,50
	1,25"	58x1/6"	52	91	102		441313	Anfrage	441413	Anfrage
	1,5"	65x1/6"	60	94	132		441304	173,60	441404	219,70
	2"	78x1/6"	60	100	132		441305	185,70	441405	236,10
	2,5"	95x1/6"	61,5	109	132		441306	227,30	441406	292,40
	3"	104x1/6"	75	124	165		441307	329,70	441407	429,70
	4"	130x1/4"	83	135	165		441308	408,60	441408	531,80
<b>Antriebe, Dichtungen etc. siehe Armaturen und Zubehör.</b> <b>Actuators, gaskets etc. see fittings and accessories.</b>										

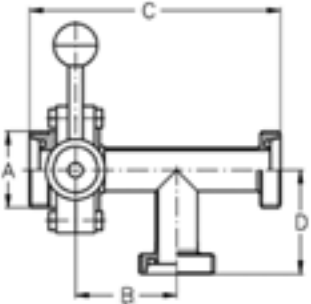
Rohrverschraubungen DIN 11851 + SMS							Art.No.	EUR	Art.No.	EUR
<b>T-Scheibenventil L/GGG</b> <b>T-butterfly valve L/GGG</b> 	DN	A	B	C	D		AISI304-VMQ		AISI316L-VMQ	
	25	52x1/6"	69	173	72		443033	Anfrage	443133	Anfrage
	32	58x1/6"	75	184	77		443034	Anfrage	443134	Anfrage
	40	65x1/6"	80	198	82		443035	Anfrage	443135	Anfrage
	50	78x1/6"	89	218	93		443036	Anfrage	443136	Anfrage
	65	95x1/6"	102	244	105		443037	Anfrage	443137	Anfrage
	80	110x1/4"	115	280	115		443038	Anfrage	443138	Anfrage
	100	130x1/4"	130	312	130		443039	Anfrage	443139	Anfrage
	125	160x1/4"	300	533,5	233,5		443041	Anfrage	443141	Anfrage
	150	190x1/4"	326	601	275		443042	Anfrage	443142	Anfrage
<b>Antriebe, Dichtungen etc. siehe Armaturen und Zubehör.</b> <b>Actuators, gaskets etc. see fittings and accessories.</b>										

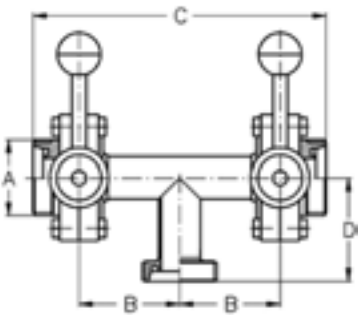
<b>T-Scheibenventil LR/GGG</b> <b>T-butterfly valve LR/GGG</b> 	DN	A	B	C	D		AISI304-VMQ		AISI316L-VMQ	
	25	52x1/6"	69	202	72		443433	Anfrage	443533	Anfrage
	32	58x1/6"	75	214	77		443434	Anfrage	443534	Anfrage
	40	65x1/6"	80	232	82		443435	Anfrage	443535	Anfrage
	50	78x1/6"	89	250	93		443436	Anfrage	443536	Anfrage
	65	95x1/6"	102	278	105		443437	Anfrage	443537	Anfrage
	80	110x1/4"	115	330	115		443438	Anfrage	443538	Anfrage
	100	130x1/4"	130	364	130		443439	Anfrage	443539	Anfrage
	125	160x1/4"	-	600	233,5		443441	Anfrage	443541	Anfrage
	150	190x1/4"	-	652	275		443442	Anfrage	443542	Anfrage
<b>Antriebe, Dichtungen etc. siehe Armaturen und Zubehör.</b> <b>Actuators, gaskets etc. see fittings and accessories.</b>										

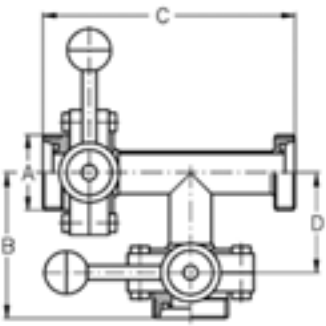
<b>T-Scheibenventil LM/GGG</b> <b>T-butterfly valve LM/GGG</b> 	DN	A	B	C	D		AISI304-VMQ		AISI316L-VMQ	
	25	52x1/6"	101	173	69		443633	Anfrage	443733	Anfrage
	32	58x1/6"	107	184	75		443634	Anfrage	443734	Anfrage
	40	65x1/6"	116	198	80		443635	Anfrage	443735	Anfrage
	50	78x1/6"	125	218	89		443636	Anfrage	443736	Anfrage
	65	95x1/6"	139	244	101		443637	Anfrage	443737	Anfrage
	80	110x1/4"	165	280	115		443638	Anfrage	443738	Anfrage
	100	130x1/4"	182	312	130		443639	Anfrage	443739	Anfrage
	125	160x1/4"	300	533,5	-		443641	Anfrage	443741	Anfrage
	150	190x1/4"	326	601	-		443642	Anfrage	443742	Anfrage
<b>Antriebe, Dichtungen etc. siehe Armaturen und Zubehör.</b> <b>Actuators, gaskets etc. see fittings and accessories.</b>										

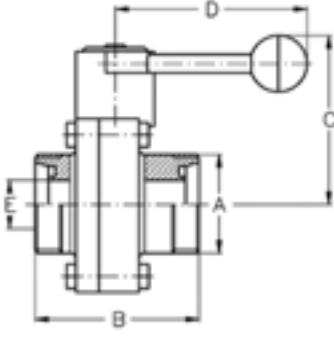
Rohrverschraubungen DIN 11851 + SMS							Art.No.	EUR	Art.No.	EUR
<b>Kugelventil EA, GG</b> Ball valve EA, GG 	DN	A	B	C	D	E	AISI304-PTFE		AISI316L-PTFE	
	25	52x1/6"	86	91	102	26	441733	Anfrage	441833	Anfrage
	32	58x1/6"	86	94	132	32	441734	Anfrage	441834	Anfrage
	40	65x1/6"	92	100	132	38	441735	Anfrage	441835	Anfrage
	50	78x1/6"	106	109	132	50	441736	Anfrage	441836	Anfrage
	65	95x1/6"	131	124	165	66	441737	Anfrage	441837	Anfrage
	80	110x1/4"	172	135	165	81	441738	Anfrage	441838	Anfrage
	100	130x1/4"	195	162	216	100	441739	Anfrage	441839	Anfrage
Antriebe etc. auf Anfrage. Actuators etc. on inquiry.										

B3

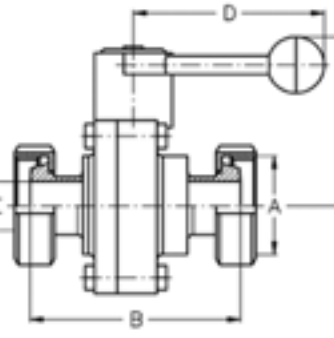
<b>Kugelventil EA, KK</b> Ball valve EA, KK 	DN	A	B	C	D	E	AISI304-PTFE		AISI316L-PTFE	
	25	52x1/6"	111	91	102	26	441933	Anfrage	442033	Anfrage
	32	58x1/6"	122	94	132	32	441934	Anfrage	442034	Anfrage
	40	65x1/6"	140	100	132	38	441935	Anfrage	442035	Anfrage
	50	78x1/6"	160	109	132	50	441936	Anfrage	442036	Anfrage
	65	95x1/6"	182	124	165	66	441937	Anfrage	442037	Anfrage
	80	110x1/4"	214	135	165	81	441938	Anfrage	442038	Anfrage
	100	130x1/4"	278	162	216	100	441939	Anfrage	442039	Anfrage
Antriebe etc. auf Anfrage. Actuators etc. on inquiry.										

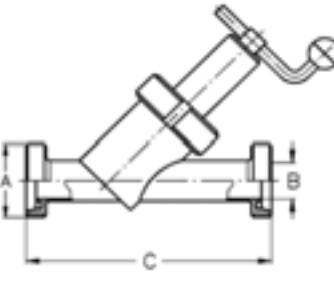
<b>Schrägsitzventil GG</b> Inclined seat valve GG 	DN	A	B	C				AISI304	
	25	52x1/6"	26	200				443833	Anfrage
	32	58x1/6"	32	200				443834	Anfrage
	40	65x1/6"	38	210				443835	Anfrage
	50	78x1/6"	50	220				443836	Anfrage
	65	95x1/6"	66	280				443837	Anfrage
	80	110x1/4"	81	320				443838	Anfrage
	100	130x1/4"	100	350				443839	Anfrage

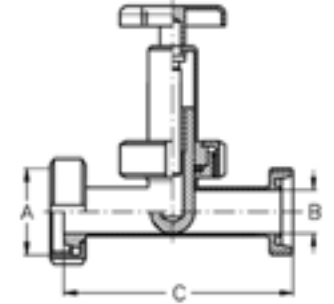
<b>Drosselventil KG</b> Throttle valve KG 	DN	A	B	C				AISI304	
	25	52x1/6"	26	137				443933	Anfrage
	32	58x1/6"	32	147				443934	Anfrage
	40	65x1/6"	38	157				443935	Anfrage
	50	78x1/6"	50	179				443936	Anfrage
	65	95x1/6"	66	202				443937	Anfrage
	80	110x1/4"	81	222				443938	Anfrage
	100	130x1/4"	100	260				443939	Anfrage

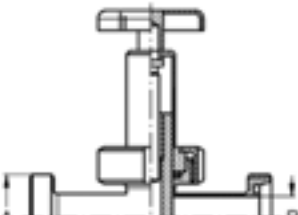
Rohrverschraubungen DIN 11851 + SMS							Art.No.	EUR	Art.No.	EUR
<b>Drosselventil GG</b> <b>Throttle valve GG</b> 	DN	A	B	C			AISI304			
	25	52x1/6"	26	144				444033	Anfrage	
	32	58x1/6"	32	154				444034	Anfrage	
	40	65x1/6"	38	164				444035	Anfrage	
	50	78x1/6"	50	186				444036	Anfrage	
	65	95x1/6"	66	210				444037	Anfrage	
	80	110x1/4"	81	230				444038	Anfrage	
	100	130x1/4"	100	270				444039	Anfrage	

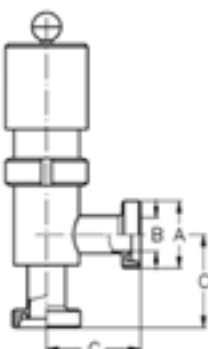
<b>Überström-Eckventil GG</b> <b>Relief angle valve GG</b> 	DN	A	B	C			AISI304		AISI316L-1.4404		
	25	52x1/6"	26	72			444533	Anfrage	444633	Anfrage	
	32	58x1/6"	32	77			444534	Anfrage	444634	Anfrage	
	40	65x1/6"	38	82			444535	Anfrage	444635	Anfrage	
	50	78x1/6"	50	93			444536	Anfrage	444636	Anfrage	
	65	95x1/6"	66	105			444537	Anfrage	444637	Anfrage	
	80	110x1/4"	81	115			444538	Anfrage	444638	Anfrage	
<b>Feder belastet</b> <b>Spring loaded</b> <b>Druckbereich angeben:</b> <b>Specify pressure range:</b> <b>0,5-1,0 / 1-2 / 2-4 / 6-8 / 8-10 bar</b>											

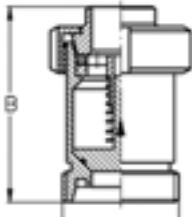
<b>Rückschlagventil GS</b> <b>Non-return valve GS</b> 	DN	A	B				AISI304		AISI316L-1.4404		
	25	52x1/6"	88				444733	Anfrage	444833	Anfrage	
	32	58x1/6"	103				444734	Anfrage	444834	Anfrage	
	40	65x1/6"	113				444735	Anfrage	444835	Anfrage	
	50	78x1/6"	114				444736	Anfrage	444836	Anfrage	
	65	95x1/6"	140				444737	Anfrage	444837	Anfrage	
	3"	104x1/6"	159				444707	Anfrage	444807	Anfrage	
	80	110x1/4"	159				444738	Anfrage	444838	Anfrage	
100	130x1/4"	180				444739	Anfrage	444839	Anfrage		

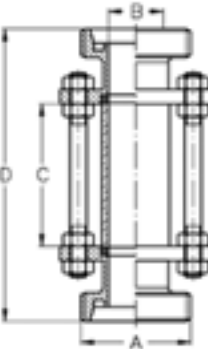
<b>Schaulaterne GG</b> <b>Cylinder sight glass GG</b> 	DN	A	B	C	D		AISI304		AISI316L-1.4404		
	10	28x1/8"	10	60	122		450130	169,10	450230	231,90	
	15	34x1/8"	16	60	122		450131	173,40	450231	241,60	
	20	44x1/6"	20	60	124		450132	194,20	450232	273,20	
	25	52x1/6"	26	70	142		450133	147,30	450233	201,10	
	32	58x1/6"	32	70	154		450134	154,50	450234	211,90	
	40	65x1/6"	38	70	165		450135	162,40	450235	Anfrage	
	50	78x1/6"	50	70	168		450136	178,80	450236	252,80	
	65	95x1/6"	66	85	191		450137	222,60	450237	317,60	
	80	110x1/4"	81	85	209		450138	310,70	450238	431,90	
	100	130x1/4"	100	115	257		450139	418,80	450239	582,60	
	125	160x1/4"	125	160	270		450141	Anfrage	450241	Anfrage	

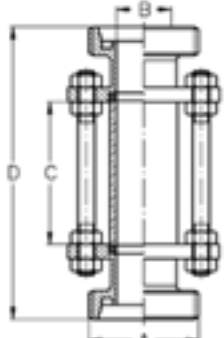
Rohrverschraubungen DIN 11851 + SMS							Art.No.	EUR	Art.No.	EUR
<b>Schaulaterne GG</b> Cylinder sight glass GG 	DN	A	B	C	D		AISI304		AISI316L-1.4404	
	150	190x1/4"	150	170	290		450142	Anfrage	450242	Anfrage
	Splitterschutz siehe Armaturen und Zubehör. Safety screen see fittings and accessories.									

B3

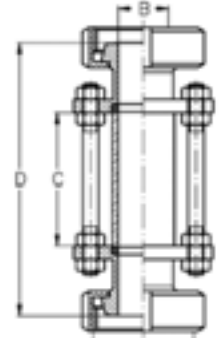
<b>Schaulaterne KK</b> Cylinder sight glass KK 	DN	A	B	C	D		AISI304		AISI316L-1.4404	
	10	28x1/8"	10	60	122		450330	178,60	450430	245,90
	15	34x1/8"	16	60	122		450331	195,20	450431	266,70
	20	44x1/6"	20	60	124		450332	206,30	450432	283,50
	25	52x1/6"	26	70	142		450333	166,90	450433	228,40
	32	58x1/6"	32	70	154		450334	179,20	450434	252,30
	40	65x1/6"	38	70	165		450335	214,10	450435	263,80
	50	78x1/6"	50	70	168		450336	210,60	450436	294,60
	65	95x1/6"	66	85	191		450337	275,40	450437	394,80
	80	110x1/4"	81	85	209		450338	383,60	450438	306,30
	100	130x1/4"	100	115	257		450339	531,90	450439	745,40
	125	160x1/4"	125	160	270		450341	Anfrage	450441	Anfrage
	150	190x1/4"	150	170	290		450342	Anfrage	450442	Anfrage
Splitterschutz siehe Armaturen und Zubehör. Safety screen see fittings and accessories.										

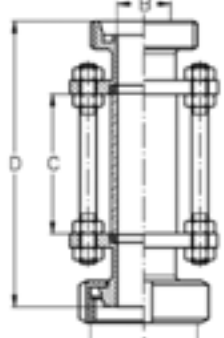
<b>Schaulaterne KG</b> Cylinder sight glass KG 	DN	A	B	C	D		AISI304		AISI316L-1.4404	
	10	28x1/8"	10	60	122		450530	180,70	450630	240,60
	15	34x1/8"	16	60	122		450531	183,40	450631	255,90
	20	44x1/6"	20	60	124		450532	201,10	450632	282,40
	25	52x1/6"	26	70	142		450533	151,40	450633	212,10
	32	58x1/6"	32	70	154		450534	169,10	450634	230,70
	40	65x1/6"	38	70	165		450535	180,30	450635	244,90
	50	78x1/6"	50	70	168		450536	195,60	450636	273,60
	65	95x1/6"	66	85	191		450537	253,40	450637	238,60
	80	110x1/4"	81	85	209		450538	236,40	450638	484,70
	100	130x1/4"	100	115	257		450539	474,80	450639	664,90
	125	160x1/4"	125	160	270		450541	Anfrage	450641	Anfrage
	150	190x1/4"	150	170	290		450542	Anfrage	450642	Anfrage
Splitterschutz siehe Armaturen und Zubehör. Safety screen see fittings and accessories.										

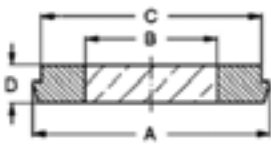
Rohrverschraubungen DIN 11851 + SMS							Art.No.	EUR	Art.No.	EUR
<b>Schauglas verschmolzen</b> <b>Sight glass fused</b>  	DN	A	B	C	D	bar			1.4462-Borosilikat	
	32	50	23	41	13	40			450734	212,60
	40	56	25	48	13	40			450735	219,60
	50	68,5	35	61	14	25			450736	239,40
	65	86	45	79	16	25			450737	305,60
	80	100	50	93	16	16			450738	338,70
	100	121	60	114	20	16			450739	445,10
	125	150	70	137	23	16			450741	590,70
	150	176	80	163	24	16			450742	741,30
-30 °C bis 280 °C -30 °C up to 280 °C										

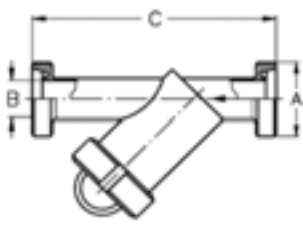
<b>Schmutzfänger GG</b> <b>Dirt collecting filter GG</b>  	DN	A	B	C			AISI304		AISI316L-1.4404	
	25	52x1/6"	26	200			453133	Anfrage	453233	Anfrage
	32	58x1/6"	32	200			453134	Anfrage	453234	Anfrage
	40	65x1/6"	38	210			453135	Anfrage	453235	Anfrage
	50	78x1/6"	50	220			453136	Anfrage	453236	Anfrage
	65	95x1/6"	66	280			453137	Anfrage	453237	Anfrage
	80	110x1/4"	81	320			453138	Anfrage	453238	Anfrage
	100	130x1/4"	100	350			453139	Anfrage	453239	Anfrage
Sieblöcher Ø 1,5 mm, Sonderlochung auf Anfrage. Strainer holes Ø 1,5 mm, special design on inquiry.										

<b>Siebeinsatz für Schmutzfänger</b> <b>Strainer for dirt collecting filter</b>  	DN	A					AISI304		AISI316L-1.4404	
	25	128					453333	Anfrage	453433	Anfrage
	32	129					453334	Anfrage	453434	Anfrage
	40	141					453335	Anfrage	453435	Anfrage
	50	173					453336	Anfrage	453436	Anfrage
	65	248					453337	Anfrage	453437	Anfrage
	80	279					453338	Anfrage	453438	Anfrage
100	287					453339	Anfrage	453439	Anfrage	
Sieblöcher Ø 1,5 mm, Sonderlochung auf Anfrage. Strainer holes Ø 1,5 mm, special design on inquiry.										

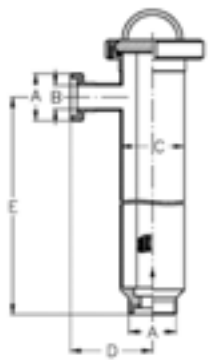
<b>Eckrohrsieb GG</b> <b>Angular filter GG</b>  	DN	A	B	C	D	E	AISI304		AISI316L-1.4404	
	25	52x1/6"	26	70	90	327	453533	Anfrage	453633	Anfrage
	32	58x1/6"	32	70	90	327	453534	Anfrage	453634	Anfrage
	40	65x1/6"	38	104	115	340	453535	Anfrage	453635	Anfrage
	50	78x1/6"	50	104	115	340	453536	Anfrage	453636	Anfrage
	65	95x1/6"	66	104	115	325	453537	Anfrage	453637	Anfrage
	80	110x1/4"	81	129	160	560	453538	Anfrage	453638	Anfrage
	100	130x1/4"	100	154	160	560	453539	Anfrage	453639	Anfrage
	125	160x1/4"	125	180	200	560	453541	Anfrage	453641	Anfrage
	150	190x1/4"	150	206	240	620	453542	Anfrage	453642	Anfrage
Sieblöcher Ø 1,5 mm, Sonderlochung auf Anfrage. Strainer holes Ø 1,5 mm, special design on inquiry.										



Rohrverschraubungen DIN 11851 + SMS							Art.No.	EUR	Art.No.	EUR
<b>Sieb für Eckrohrsieb</b> <b>Strainer for angular filter</b> 	DN	A					AISI304		AISI316L-1.4404	
	25-32	422					453733	Anfrage	453833	Anfrage
	40-65	479					453735	Anfrage	453835	Anfrage
	80	810					453738	Anfrage	453838	Anfrage
	100	793					453739	Anfrage	453839	Anfrage
	125	837					453741	Anfrage	453841	Anfrage
	150	928					453742	Anfrage	453842	Anfrage
	<b>Sieblöcher Ø 1,5 mm, Sonderlochung auf Anfrage.</b> <b>Strainer holes Ø 1,5 mm, special design on inquiry.</b>									

B3

<b>Sieb für Eckrohrsieb Gaze</b> <b>Strainer for angular filter gauze</b> 	DN	A					AISI304		AISI316L-1.4404	
	25-32	422					453933	Anfrage	454033	Anfrage
	40-65	479					453935	Anfrage	454035	Anfrage
	80	810					453938	Anfrage	454038	Anfrage
	100	793					453939	Anfrage	454039	Anfrage
	125	837					453941	Anfrage	454041	Anfrage
	150	928					453942	Anfrage	454042	Anfrage
	<b>Gaze wahlweise:</b> <b>Gauze optional:</b> 0,1/0,063 0,4/0,22 0,5/0,25 0,63/0,25									

<b>Sieb für Eckrohrsieb Gaze Spirale</b> <b>Strainer for angular filter gauze coil</b> 	DN	A					AISI304		AISI316L-1.4404	
	25-32	422					454133	Anfrage	454233	Anfrage
	40-65	479					454135	Anfrage	454235	Anfrage
	80	810					454138	Anfrage	454238	Anfrage
	100	793					454139	Anfrage	454239	Anfrage
	125	837					454141	Anfrage	454241	Anfrage
	150	928					454142	Anfrage	454242	Anfrage
	<b>Gaze innen, Spirale außen</b> <b>Gauze inside, coil outside</b>									

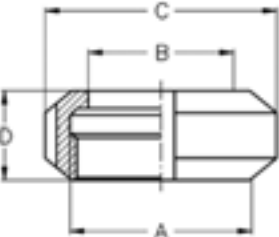
<b>SMS Nutmutter</b> <b>SMS Nut</b> 	DN	A	B	C	D		AISI304				
	25	40x1/6"	32	51	20			463303	Anfrage		
	38	60x1/6"	48	74	25			463304	Anfrage		
	51	70x1/6"	60,5	84	26			463305	Anfrage		
	63,5	85x1/6"	74	100	30			463306	Anfrage		
	76	98x1/6"	87	114	32			463307	Anfrage		
	101,6	132x1/6"	117	154	32			463308	Anfrage		

Rohrverschraubungen DIN 11851 + SMS						Art.No.	EUR	Art.No.	EUR
<b>SMS Dichtring</b> <b>SMS Gasket</b>	<b>DN</b>	<b>A</b>	<b>B</b>	<b>C</b>			<b>NBR</b>	<b>EPDM</b>	
	25	32	25	5,5			423503	5 bZU Y 423603	
	38	48	38	5,5			423504	5 bZU Y 423604	
	51	61	51	5,5			423505	5 bZU Y 423605	
	63,5	73,5	63,5	5,5			423506	5 bZU Y 423606	
	76	86	76	5,5			423507	5 bZU Y 423607	
	101,6	113,5	101,6	5,5			423508	5 bZU Y 423608	

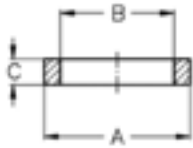

B3

	<b>DN</b>	<b>A</b>	<b>B</b>	<b>C</b>			<b>FKM</b>	<b>PTFE</b>
	25	32	25	5,5			423703	5 bZU Y 423803
	38	48	38	5,5			423704	5 bZU Y 423804
	51	61	51	5,5			423705	5 bZU Y 423805
	63,5	73,5	63,5	5,5			423706	5 bZU Y 423806
	76	86	76	5,5			423707	5 bZU Y 423807
	101,6	113,5	101,6	5,5			423708	5 bZU Y 423808

<b>SMS Gewindestutzen</b> <b>SMS Threaded ferrule</b>	<b>DN</b>	<b>A</b>	<b>B</b>	<b>C</b>			<b>AISI304</b>	<b>AISI316L-1.4404</b>
	25	40x1/6"	22,5	15			461903	5 bZU Y 462003
	38	60x1/6"	35,5	20			461904	5 bZU Y 462004
	51	70x1/6"	48,5	20			461905	5 bZU Y 462005
	63,5	85x1/6"	60,5	24			461906	5 bZU Y 462006
	76	98x1/6"	73,1	24			461907	5 bZU Y 462007
	101,6	132x1/6"	97,6	35			461908	5 bZU Y 462008

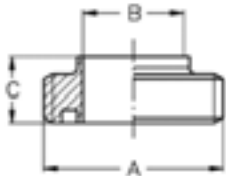

<b>SMS Bundstutzen</b> <b>SMS Liner</b>	<b>DN</b>	<b>A</b>	<b>B</b>	<b>C</b>			<b>AISI304</b>	<b>AISI316L-1.4404</b>
	25	35,5	22,5	8			462703	5 bZU Y 462803
	38	55	35,5	9			462704	5 bZU Y 462804
	51	65	48,5	9			462705	5 bZU Y 462805
	63,5	80	60,5	9			462706	5 bZU Y 462806
	76	93	72	10			462707	5 bZU Y 462807
	101,6	127	97,6	12			462708	5 bZU Y 462808

